

# RL-H5A

## PRECAUTIONS

### Charging Battery

- Be sure to charge the battery within the charging temperature range.  
Charging temperature range: 10 to 40°C
- Use only the specified battery or the battery charger. Failures caused by using other batteries or battery chargers are out of warranty including the main unit.

### Warranty policy for Battery

- Battery is an expendable item. The decline in retained capacity depending on the repeated charging/discharging cycle is out of warranty.

### Other precautions

- Before starting work or during operation, check that the instrument is functioning correctly and performance is normal.
- Protect the instrument from heavy shocks or vibration.
- Remove batteries before storing when the instrument will not be used for periods on 1 month or more. Batteries may leak fluid when left inside the instrument causing malfunction.

### Maintenance

- Always clean the instrument before returning it to the case.
- Wipe off moisture completely if the instrument gets wet during survey work.
- Store the instrument in a dry room where the temperature remains fairly constant.

- If the instrument is dirty, carefully wipe it with a soft, dry cloth. To clean the instrument or the carrying case, lightly moisten a soft cloth in a mild detergent solution. Wring out excess water until the cloth is slightly damp, then carefully wipe the surface of the unit. Do not use any alkaline cleaning solutions, alcohol, or any other organic solvents on the instrument.

### Exporting this product (Relating EAR)

This product is equipped with the parts/units, and contains software/technology, which are subject to the EAR (Export Administration Regulations). Depending on countries you wish to export or bring the product to, a US export license may be required. In such a case, it is your responsibility to obtain the license. The countries requiring the license as of Aug. 2017 are shown below. Please consult the Export Administration Regulations as they are subject to change.  
North Korea, Iran, Syria, Sudan, Cuba  
URL for the EAR of the US: <http://www.bis.doc.gov/policiesandregulations/ear/index.htm>

### EXCEPTIONS FROM RESPONSIBILITY

- The manufacturer, or its representatives, assumes no responsibility for any damage, or loss of profits (change of data, loss of data, loss of profits, an interruption of business etc.) caused by use of the product or an unusable product.
- The manufacturer, or its representatives, assumes no responsibility for any damage, or loss of profits caused by usage different to that explained in this manual.
- The manufacturer, or its representatives, assumes no responsibility for consequential damage, or loss of profits due to heavy rain, strong wind, high-temperature and humidity, or storing or use of the product under unusual conditions.
- Product failures caused by rebuilding are out of warranty.
- Cautions and warnings included in this manual do not cover all the possible events.

## Class 2 Laser Product

Thank you for selecting our products.

- Please read this Instruction manual carefully, when using this product.
- The specifications and general appearance of the instrument, and the content of this manual are subject to change without notice.
- Some of the diagrams shown in this manual may be simplified for easier understanding.
- Always keep this manual in a convenient location and read it when necessary.
- Please read the Instruction manual of the paired instrument in conjunction with this manual.

1020988-01-A

## LASER SAFETY INFORMATION

The RL-H5A is classified as a Class 2 Laser Product according to IEC Standard Publication 60825-1 Ed.3.0: 2014 and United States Government Code of Federal Regulation FDA CDRH 21CFR Part1040.10 and 1040.11 (Complies with FDA performance standards for laser products except for deviations pursuant to Laser Notice No.50, dated June 24, 2007.)

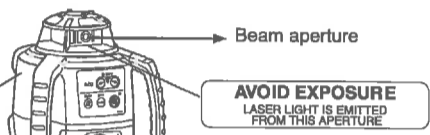

### CAUTION

- Perform checks at start of work and periodic checks and adjustments with the laser beam emitted under normal conditions.
- When the instrument is not being used, turn off the power.
- When disposing of the instrument, destroy the battery connector so that the laser beam cannot be emitted.
- Operate the instrument with due caution to avoid injuries that may be caused by the laser beam unintentionally striking a person in the eye. Avoid setting the instrument at heights at which the path of the laser beam may strike pedestrians or drivers at head height.

### WARNING

- Use of controls or adjustments or performance of procedures other than those specified herein may result in hazardous radiation exposure.
- Never intentionally point the laser beam at another person. The laser beam is injurious to the eyes and skin. If an eye injury is caused by exposure to the laser beam, seek immediate medical attention from a licensed ophthalmologist.
- Do not look directly into the laser beam. Doing so could cause permanent eye damage.
- Do not stare at the laser beam. Doing so could cause permanent eye damage.

## HOW TO STORE

After using the instrument, store it as shown below.

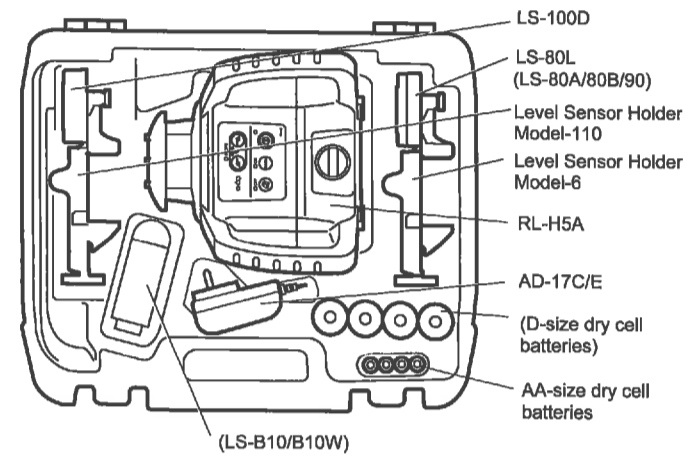

- LS-70 cannot be stored.
- For LS-100D and Holder Model-110, refer to the instruction manual of LS-100D.

## NOMENCLATURE AND FUNCTIONS

### Battery power lamp (Red)

Blinking:  
The power is low, but laser is still usable. (Blinking continues for one minute.)  
Solid:

Dead batteries. Replace the batteries with new ones. (The lamp is solid for five minutes, then turned off automatically.)

**Manual mode ON lamp (Red)**  
Self-leveling does not function.

**Height alert OFF lamp (Red)**  
Height alert function is not active.

**Height alert OFF key**  
OFF: Push twice continuously.  
ON: Push once.  
☑ Height alert function (Refer to the description on the back page.)

**Manual mode ON key**  
ON: Push twice continuously.  
OFF: Push once.

**Note: In manual mode**

- Self-leveling function is not active.
- Height alert function is not active.
- Setting slope function is not active.

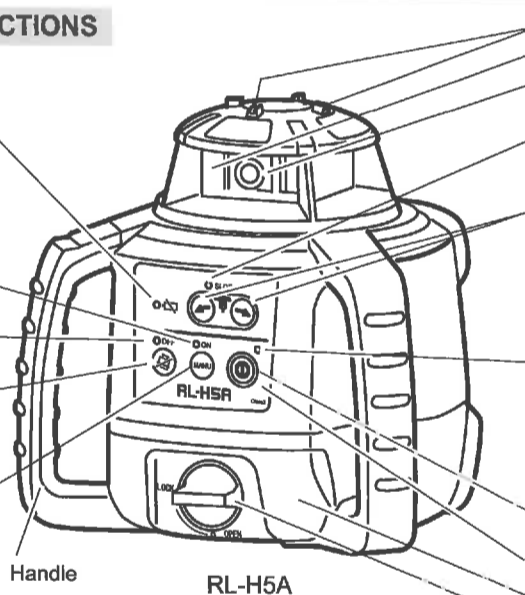

**Sight**  
**Protective glass**

**Rotary head**  
Laser beam emits from here.

**Slope lamp (Green)**  
☑ Aligning Direction of Slope (Refer to the description on the back page.)

**Slope key**  
Tilts beam plane in direction of arrow. This key does not function during self-leveling and in the "Manual" mode.

☑ Aligning Direction of Slope (Refer to the description on the back page.)

**Power lamp/Self-leveling lamp (Green)**  
Blinking quickly : Self-leveling is in process.  
Blinking slowly : Self-leveling is almost complete.  
Solid : Self-leveling is complete.

☑ Self-leveling function (Refer to the description below.)

**Power switch**  
Turn the instrument ON or OFF.

**Control panel**

**Battery holder**

**Battery holder knob**

### Self-leveling function

When the power is turned on, the laser beam is automatically positioned within the accuracy range by the self-leveling function.

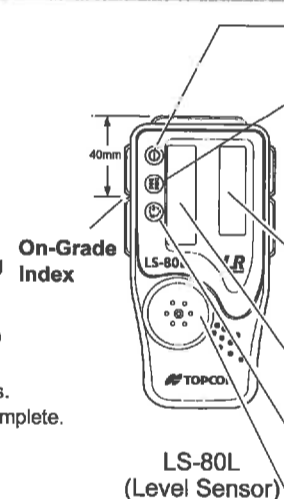

### Power switch

The power switch turns ON or OFF by pressing.

### On-Grade precision switch

Two on-grade precision options are available, normal precision (±2mm) and high precision (±1mm). By pressing this switch, the precision options are switched alternately. Confirm the precision choice by the indicator. (Normal precision is the default setting each time the sensor is turned on.)

### Indicator

The indicators are located on front and back sides of the instrument.  
☑ LS-80L Indicator (Refer to the description on the back page.)

### Beam receiving window

Turn the beam receiving window side towards RL-H5A to detect the laser beam.

### Buzzer sound switch

Volume of the sensor buzzer can be alternately switched to LOW/LOUD/OFF by pressing the switch.

### Buzzer speaker

### Auto-cut off function

The power will be turned off automatically if no laser beam is detected for approximately 30 minutes. (To turn on the level sensor, press the power switch again.)

## POWER SOURCE

### RL-H5A (Using the rechargeable battery)

Be sure to charge the battery fully before using it for the first time or after not using it for long periods.

#### Charging

- 1 Remove the DB-79A battery holder by turning battery holder knob to "OPEN" side.
- 2 Connect the AD-17C/E into the charger port of the battery pack BT-79Q.
- 3 Plug the AD-17C/E into the wall outlet.  
When charging starts, the LED is solid red. The LED is off when charging finished.
- 4 Unplug the AD-17C/E from the battery pack BT-79Q and disconnect the AD-17C/E power plug from the wall outlet.

#### The LED of BT-79Q indicates the charging status:

- Red ON : Charging.  
OFF : Charging completed.  
Red blinking slowly : NI-MH BT-79Q battery pack protection feature is working automatically. Let the battery pack fall within its designated charging temperature range (10 to 40°C), unplug the AD-17C/E from the battery pack and then check the LED status. Solid red LED indicates charging has started again. Slow blinking red LED indicates the NI-MH battery is still out of the charging temperature range. Wait for a while, unplug the AD-17C/E and then check the LED again.  
The instrument has a protection feature which works when the batteries are under a high or low temperature state. In such a case, charging will stop automatically to protect nickel hydride batteries.  
Red blinking quickly: The battery is not charged properly. Please contact your local dealer.

- The charger will become rather hot during use. This is normal.
- Do not use batteries other than those designated.
- For longer battery life, conform to the suggested charging time to the extent possible.
- Be sure to charge stored battery source every 3 or 6 months and store in a place at 30°C or below. If you allow the battery to become completely discharged, it will have an effect on future charging.
- Batteries generate power using a chemical reaction and as a result have a limited lifetime. Even when in storage and not used for long periods, battery capacity deteriorates with the passage of time. This may result in the operating time of the battery shortening despite having been charged correctly. In this event, a new battery is required.

#### Installing

- 1 Insert the battery pack BT-79Q into the DB-79A battery holder.
- 2 Install the battery holder. Tighten the battery cover knob to "LOCK" side.

- It is possible to remove the battery pack BT-79Q from the DB-79A battery holder and use the dry cell batteries. Grasp the specified place on the battery holder, which is shown on the right, and remove the battery pack.

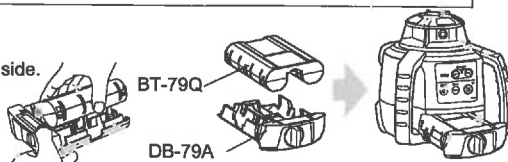

### RL-H5A (Using the dry cell batteries)

#### Replacing the dry cell batteries

- 1 Remove the DB-79A battery holder by turning battery holder knob to "OPEN" side.
- 2 Install the new 4xD size dry cell batteries (alkaline) referring to the illustration on the battery holder.\*1), 2), 3)
- 3 Install the battery holder. Tighten the battery cover knob to "LOCK" side.

- \*1 Replace all 4 batteries with new ones at the same time. Do not mix used and new batteries, and do not mix different types of batteries together.
- \*2 Use alkaline dry cells. Nickel hydrogen dry cells and nickel cadmium dry cells can be used too, but the operating time is different from the time of alkaline dry cells.
- \*3 Generally, performances of dry cell deteriorate temporarily in low temperature, but recover in normal temperature.

- It is possible to remove the dry cell batteries from the DB-79A battery holder and use the battery pack BT-79Q.

#### LS-80L

#### Replacing the dry cell batteries

- 1 Keep pushing the battery cover in 1 direction, and then try to slide the cover in 2 direction. The cover does not move but it will be open.
- 2 Take out the batteries and place new ones (2xAA size alkaline dry cell batteries) into the battery box.
- 3 Press the lid down and click to close.

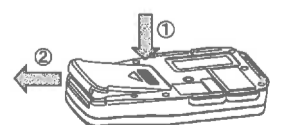
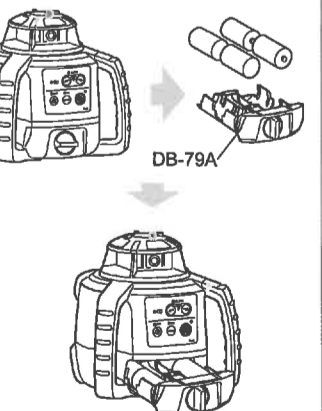

## OPERATION

### How To Operate

- Set the instrument to the tripod or smooth surface. Make sure instrument is roughly level.
- Press power switch (ON).

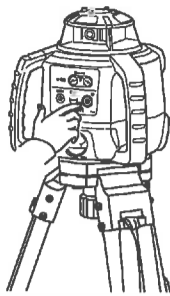

- Press power switch on level sensor (ON).
- Select the precision mode by pressing the On-Grade precision switch.
- Locate the on-grade position "—" by moving the level sensor up and down.



- Mark the position of On-Grade index. (Top of the level sensor is 40mm [1 9/16"] from index for offset marking.)

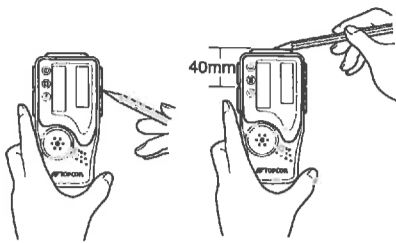

### LS-80L Indicator

Height alert warning of rotating laser\*1

A flash and a buzzer sound signifies that the height alert function of rotating laser is operating.

Rotating laser battery warning\*2

A flash shows that the rotating laser power is low.

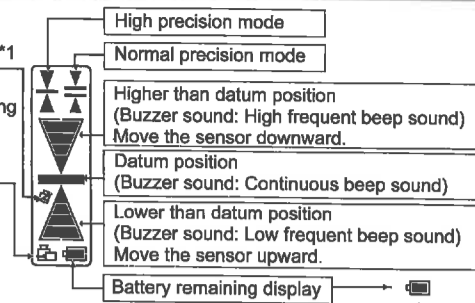

### Detective Range

Display	Precision
	High ±1mm (2mm width)
	Normal ±2mm (4mm width)
	Level sensor is moved upward or downward from laser beam.

- Battery is sufficient.
- The power is low, but laser is still usable.
- Dead battery. Replace the dry battery with new one.

Note: The warning displays \*1 and \*2 are the functions that the level sensor detects alarm signal from the rotating laser. The level sensor can be canceled the alarm detection from the rotating laser. To be canceled the detection; Press the power switch while pressing the buzzer sound switch when powering on.

### Height Alert Function

When the instrument system detects a shock, this function informs the operator of it.

- When the instrument's installation status (height) is sharply changed by the contact of the operator or the like, this function stops self-leveling to keep the operation accuracy and informs the operator of the situation. The three lamps blink at the same time as shown at the right.
- After 1 minute has passed since the self-leveling function was activated and the laser beam was emitted, this function works.
- The height alert function does not work in the "Manual" mode.

Shock is given to the instrument.

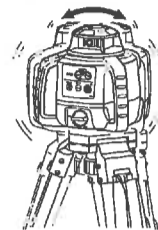

Height alert status

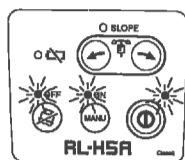

The three lamps blink at the same time and the rotary head rotates at low speed.

### [How to reset]

- Turn off the power switch.
- Check whether the instrument is installed correctly.
- Turn on the power switch. Self-leveling starts again. After self-leveling is finished, the laser beam is emitted.
- Make sure that the laser beam is set at the correct height. Then, restart the operation.

### Lamp Position

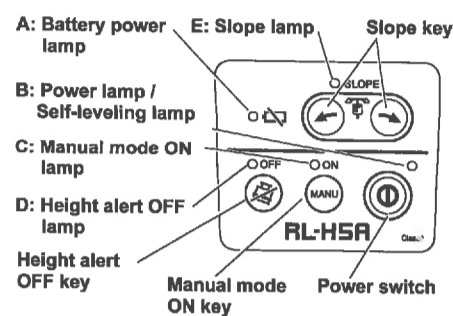

### Aligning Direction of Slope

It is possible to set slope only in the X axis direction (refer to "CHECKS AND ADJUSTMENTS").

#### [1. Installation of the instrument]

When using the laser to set the slope, the laser must be properly aligned so the slope axis of the laser beam is parallel to the desired direction of slope.

The sight on top of the instrument is calibrated to the slope axis of the laser beam. Follow the steps below to align the laser to the desired direction of slope:

- Establish a target line parallel to desired direction of slope.
- Set up the laser over this line (drop a plumb bob from the tripod mounting screw).
- Rough align the instrument to the direction of slope. Make sure it is properly oriented for the slope to be set.
- Using the sight, position the instrument so the sight is centered on the target. (see illustration below)



#### [2. Setting slope]

Operating procedure (Setting slope)	Key operation	Lamp display (Refer to the right illustration)
1 Press Power switch ON. You can set the slope after self-leveling is completed.	Power switch	During self-leveling: Lamp B blinks. After self-leveling is completed: Lamp B lights.
2 Press one of Slope keys once. The laser beam keeps sloping in the direction of the pressed key.	Slope key	Lamp E blinks quickly.
3 Press the Slope key again. The laser beam stops sloping. (Unless you press the Slope key again, the laser beam is set horizontally.)	Slope key	Lamp E lights.
4 Press the Slope key to adjust the slope. How long you press the Slope key can change the laser beam sloping speed. The blinking speed of the lamp provides a visual indication of the beam movement speed.	Slope key	When Slope key is not pressed: Lamp E lights. Slope key Press for a shorter time: Lamp E Blinks slowly, Beam movement Moves slowly Press for a longer time: Blinks quickly, Moves quickly
5 Press Power switch OFF to cancel the slope setting.	Power switch	All lamps are OFF.

- After setting the slope, the self-leveling does not function in the X axis direction.

### How to set the slope before the power is OFF again

- To set the slope before the power is OFF again, turn on the Power switch as pressing either right or left of the Slope keys. The slope is kept and you can adjust the slope in the same way as Step 4. (When the Power switch is ON without the Slope key pressed, the laser beam will return to level.)

- When you set the "Manual" mode to ON after setting the slope, the beam is fixed at the set slope position. At this time the Slope key does not function. For information about Manual mode ON/OFF, refer to "NOMENCLATURE AND FUNCTIONS".
- Check the beam often during slope use for slope accuracy. Check instrument calibration periodically.

## CHECKS AND ADJUSTMENTS

### Checking and adjusting calibration

Horizontal calibration of the laser beam can be checked by the user.

#### [Checking]

- Set up a tripod approx. 50m (160ft) from a wall. Mount the instrument on the tripod, facing the X1 side toward the wall.
- Turn the instrument on and allow self-leveling to complete.
- Put the level sensor in fine detection mode by pressing the On-Grade precision switch.
- By using the level sensor, mark the center position of laser beam on the wall. (X1)
- Turn off the instrument. Loosen the tripod screw, rotate the instrument 180 degrees and re-secure it on the tripod. The X2 side of the instrument faces toward the wall. When rotating the instrument, avoid changing the height.
- Turn the unit on again and allow self-leveling to complete.
- By using the level sensor, mark the center position of laser beam on the wall. (X2)
- If the difference value of marked two laser beam heights (difference value of X1 and X2) are less than 5mm, adjustments are not needed. The difference value is greater than 5mm, adjust the instrument as described in right.\*
- Check the Y side as the same way.

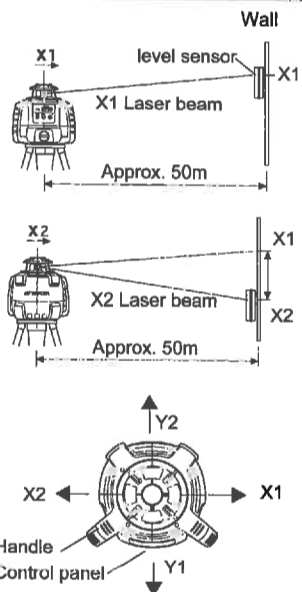

\* If the difference value is greater than 40mm (±90°), it exceeds the adjustment range. Please contact your local dealer.

#### [To calibrate the X axis]

- Face the X1 side of the instrument toward a wall, press the Power switch while pressing the height alert OFF key. Then the height alert OFF lamp will light, and manual mode ON lamp will blink. (X axis is selected.)
- Press the height alert OFF key to calibrate the X axis. The manual mode ON lamp will light. When self-leveling finishes, the laser beam will emit.
- Using the level sensor, mark the on-grade height of laser beam on a wall.
- Rotate the instrument 180 degrees to face X2 side toward a wall.
- In the same way as step 3, mark the on-grade height of laser beam on a wall.
- Press the slope key to make adjustment so that the laser beam height may be at the center between the positions of Step 3 and Step 5.
- Press the height alert OFF key to memorize the new laser beam calibration. The height alert OFF lamp will blink. Power will shut off automatically when the calibration memorization is complete. The X axis adjustment is completed now.

#### [To calibrate the Y axis]

- Face the Y1 side of the instrument (Control panel side) toward a wall, press the Power switch while pressing the height alert OFF key. Then the height alert OFF lamp will light, and manual mode ON lamp will blink. (Y axis is selected.)
- Press the right Slope key once again. The self-leveling lamp will blink. (Y axis is selected.)
- Press the height alert OFF key to calibrate the Y axis. The self-leveling lamp will light.
- Using the level sensor, mark the on-grade height of laser beam on a wall.
- Rotate the instrument 180 degrees to face Y2 side toward a wall.
- In the same way as step 4, mark the on-grade height of laser beam on a wall.
- Press the slope key to make adjustment so that the laser beam height may be at the center between the positions of Step 4 and Step 6.
- Press the height alert OFF key to memorize the new laser beam calibration. The height alert OFF lamp will blink. Power will shut off automatically when the calibration memorization is complete. The Y axis adjustment is completed now.

If the height alert OFF lamp blinks quickly and the power is not automatically turned off when pressing the height alert OFF key to memorize the height, the height exceeds the adjustment range. Please contact your local dealer.

To discontinue calibration the instrument, press the Power switch.

### Checking cone error

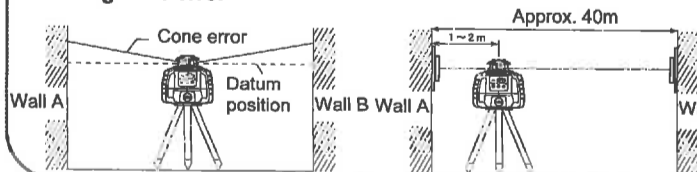

Perform the following check after completing horizontal calibration procedure.

#### [Checking]

- Set up the laser centered between two walls approximately 40m (131ft) apart. Orient the instrument so one axis, either X or Y, is facing the walls.
- Locate and mark the position of the rotating laser beam on both walls using the level sensor.
- Turn off the instrument and move the instrument closer to wall A (1m to 2m / 3 ft to 6 ft). Do not change the axis orientation of the instrument. Turn the instrument on.
- Again locate and mark the position of the rotating laser beam on both walls using the level sensor.
- Measure the distance between the first and second marks on each wall. If the difference between each set of marks is less than 4mm (5/32 of an inch), no error exists.

\* If the difference value is greater than 4mm (5/32 inch), contact your local dealer.

## ERROR CODE

Use the table below to determine operation errors indicated by blinking lamps on the control panel. (For the lamp indication, refer to "Lamp position".) If corrective action listed does not correct error, please contact your local dealer.

Lamp indication	Error Code	Corrective Action
Lamp B, C and D blink in turn	Self-leveling range error	Correct tilt of the instrument until it less than 5 degrees.
Lamp A lights	Battery power error	Replace the four alkaline dry cell batteries with new ones at a time or charge the battery pack.
Lamp B, C and D blink simultaneously	Height alert error	Turn power off, rough level the instrument, then turn power on again. Check height of laser beam as it may have changed.
Lamp D blinks quickly	Calibration error	Repeat calibration procedure. If error repeats contact your local dealer.
Lamp E lights	Checking and adjusting calibration error	Push the slope key of the opposite side, and align slope.
Lamp B, C and D blink in turn	Internal error	Turn power off, then on again in stable locations. If error repeats contact your local dealer.

## SPECIFICATIONS

### RL-H5A

Laser source:	Laser diode (Visible, 635 nm)
Laser output:	IEC Class 2
Self-leveling range:	0.9 mW
Accuracy:	±5"
Manual slope settable range:	±10"
Rotational speeds:	±5° (When the instrument is installed on the 0° surface) The slope range is increased or decreased according to the tilt of the surface on which the instrument is installed.
Operating range:	600 r.p.m
Power source/Operating time at 20°C (68°F):	Diameter Approx. 2 to 800 m (When using LS-80L)
Charging time:	4xD size dry cell batteries (alkaline) /100 hours Ni-MH battery pack BT-79Q (7000mAh) /60 hours about 13 hours (Using with AD-17C/E)
Dust and water resistance:	IP66 (IEC60529: 2001)
Operating temperature:	10 to 40°C (50 to 104°F)
Storable temperature range:	-20 to 50°C (-4 to 122°F)
Remote warning display:	-30 to 60°C (-22 to 140°F)
Size:	RL-H5A height alert warning (Warning is displayed on the indicator of LS-80L.) RL-H5A battery warning (Warning is displayed on the indicator of LS-80L.)
Laser beam height:	172 (L) x 211 (W) x 205 (H) mm 171.8 mm (Height from the instrument's bottom surface to the center point of laser beam)
Weight:	
Dry battery type:	2.3 kg (5.1 lbs) (with dry cell batteries)
Rechargeable battery type:	2.5 kg (5.5 lbs) (with BT-79Q)

BT-79Q (Ni-MH rechargeable battery)	
Nominal voltage:	4.8V
Capacity:	7,000mAh
Size:	104(W) x 127(D) x 37(H) mm
Weight:	690 g
AD-17C/E	
Input voltage:	100 to 240 V AC, 50 to 60 Hz, 0.6 A
Output voltage:	DC 9 V/2.0 MAX 18 W
Charging time:	about 13 hours
Charging temperature range:	10 to 40°C (50 to 104°F)
Storage temperature range:	-20 to 70°C (-4 to 158°F)
Size (excluding cable)/ Weight	
AD-17C:	45(W) x 83(D) x 70(H) mm /137 g
AD-17E:	45(W) x 83(D) x 62(H) mm /140 g
LS-80L	
Beam detection width:	50 mm (2.0 in)
On-Grade precision:	High: ±1 mm (±0.04 in) Normal: ±2 mm (±0.08 in)
Beam detection indication:	Liquid crystal (both sides) and buzzer
Power source:	2xAA size dry cell batteries
Operating time (at 20°C):	about 120 hours (Using alkaline manganese dry cell batteries) after 30 minutes (without beam detection)
Automatic shutdown:	
Dust and water resistance:	IP66 (IEC60529: 2001)
Operating temperature:	-20 to 50°C (-4 to 122°F)
Storage temperature:	-30 to 60°C (-22 to 140°F)
Size:	146(L)x76(W)x28(H) mm
Weight:	0.19 kg (0.41 lbs) (with dry cell batteries)



## TOPCON CORPORATION (Manufacturer)

75-1 Hasunuma-cho, Itabashi-ku, Tokyo 174-8580, Japan <http://www.topcon.co.jp>

Please see the following website for contact addresses.

GLOBAL GATEWAY <http://global.topcon.com/>

© 2017 TOPCON CORPORATION  
ALL RIGHTS RESERVED