

CXL4 Cable Avoidance Tool

DXL4 Depth Measuring Cable Avoidance Tool

SGA4 Signal Generator

SGV4 Signal Generator

MXL4 Precision Pipe & Cable Locator

MXT4 Transmitter



Contents

General Warnings	1	Non-Metallic Pipe Tracing	39
Features		Sonde Batteries	40
CXL4 Cable Avoidance Tool	2	Duct Sonde Batteries	41
DXL4 Cable Avoidance Tool	2	Tracing a Sonde	42-43
MXL4 Precision Pipe & Cable Locator	2	Plastic Pipe Tracers and Flexible Tracer	44-45
SGA4 Signal Generator	3-4	Depth Measurement	
SGV4 Signal Generator	3-4	Metallic Services	46-47
MXT4 Transmitter	3,5	Non-Metallic Services	
Locator Operating Modes		- Sonde/Plastic Pipe Tracers/Flexible Tracer	48
Power Mode	6	Signal Current Measurement	49-52
Radio Mode	7	Function Checks	
A/Scan Mode	8-9	Locator Function Checks	53-54
Generator/ Transmitter Mode	10	Signal Generator/ Transmitter Function Checks	55
Using the Locator		Depth Measurement Function Checks	56
Batteries	11	Data Logging	
Automatic Daily Self Test	12-13	Locators	57
Holding the Locator	14	Signal Generator/ Transmitter	58
Searching	15	GPS and Bluetooth™	59
Pinpointing	16	General Symbols	60
Alarm Zone™	17	Technical Specifications	
Tracing	18	CXL4 Cable Avoidance Tool	61
Using the Signal Generator/Transmitter	19	DXL4 Cable Avoidance Tool	61
Output Power Level and Pulsed/Continuous Output	20	MXL4 Precision Pipe & Cable Locator	62
Frequency Selection	21	SGA4 Signal Generator	63
Batteries	22-23	SGV4 Signal Generator	63
Automatic Daily Self Test	24-25	MXT4 Transmitter	64
Direct Connection	26-27	Maintenance	
Street Furniture	28-29	Handling/Cleaning/Storage	65
Signal Clamp	30	Support Services	
Signal Injector	31	Training/ Servicing/ Calibration/ Repairs	65
Searching	32		
Tracing	33		
Induction	34		
Searching	35-36		
Multiple Services	37		
Inductive Sweep	38		

GENERAL WARNINGS



ALWAYS EXCAVATE WITH CARE

C.Scope Locators detect services radiating a detectable signal. There may be some services that do not radiate a signal and cannot be located.

Do not use the equipment outside of the temperature range -10°C to +50°C (14°F to 122°F) as the batteries may cease to function adequately.

Geographical conditions such as hills and mountains may effectively screen signals and prevent a detectable Radio signal.

The Locators alone will not always locate every service. Use a Signal Generator/Transmitter wherever possible.

Do not touch the metal of the Signal Generator/Transmitter Crocodile Clips or of the Plastic Pipe Tracer or Flexible Tracer terminals when in use.

The Signal Generator/Transmitter leads MUST NOT be connected directly to a live service.

Beware of multiple services. The Locators will not always indicate services that are close together or one above the other.

Do not use the equipment in areas where hazardous gases may be present.

Check for underground services before using the Earth Stake.

Always make sure that the Locator and Signal Generator/Transmitter are set to the same frequency when used together.

Performance may be impaired by unusually strong electromagnetic fields.

Do not hold the Locator Loudspeaker close to the ear for extended periods.

It is recommended that the operation of the Locator and Signal Generator/Transmitter is regularly checked (see pages 53-56).

CXL4, DXL4 and MXL4 Locators



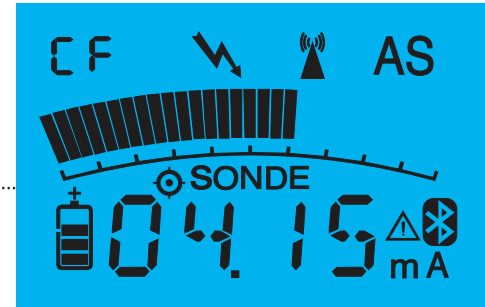
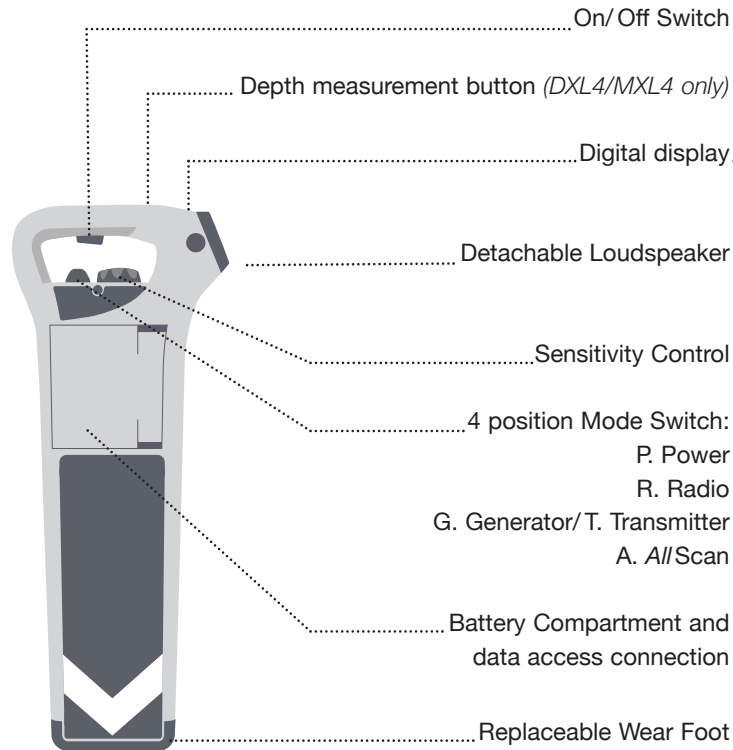



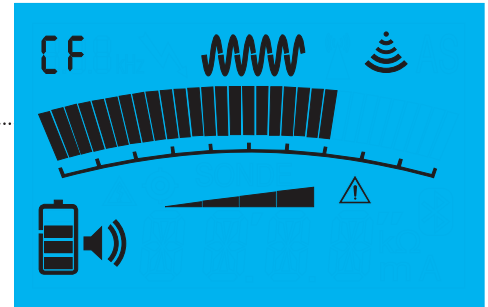
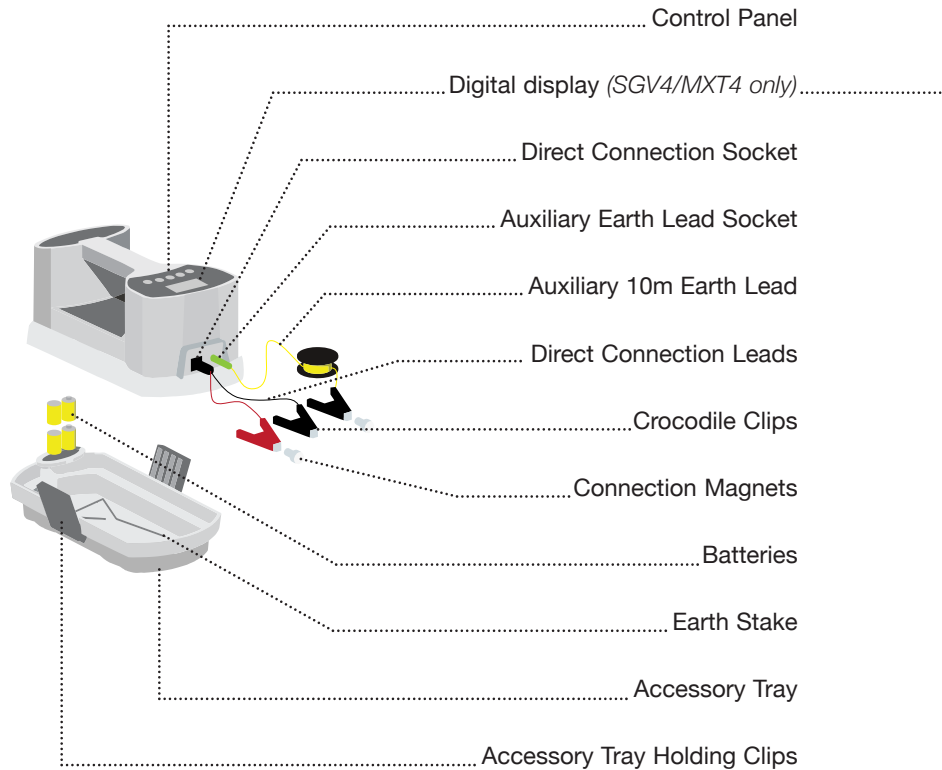

The CXL4, DXL4 and MXL4 can provide precise information about the position and depth (DXL4 and MXL4 only) of buried services. The combination of locating modes enables buried services to be detected quickly and reliably.



- Signal Strength Indicator
- 04 15** Depth display (*DXL4/MXL4 only*)
- Mode selected:
- P** Power
- R** Radio
- [CF]** **G** Generator (*CXL4/DXL4 frequency*)
- [CF]** **T** Transmitter (*MXL4 selected frequency*)
- AS** **A** All Scan
- Battery Condition Indicator
- Self Test Warning
- GPS
- Bluetooth™

SGA4/SGV4 Signal Generator and MXT4 Transmitter



-  Signal Strength Indicator
-  Output Power Level
-  Output Frequency Indicator
-  Connected Mode Indicator
-  Induced Mode Indicator
-  Battery Condition Indicator
-  Audio Level Indicator
-  Self Test Warning

SGA4 and SGV4 Signal Generator

SGA4 Signal Generator

The SGA4 Signal Generator is designed for use with the CXL4 and DXL4 Locators.

- High (One Watt) and low Power Output settings.
- Pulsed or Continuous output signal.
- Loud or Muted audible output.



SGV4 Signal Generator

The SGV4 Signal Generator is designed for use with the CXL4 and DXL4 Locators.

- Automatic Daily Self Test.
- Data Logging of all Signal Generator activity.
- Automatic Back-light.
- Four Power Output settings up to One Watt.
- Pulsed or Continuous output signal.
- Loud, Muted or Silent audible output settings.
- Combined Frequency (CF) signal output (33kHz and 131kHz) applicable using both Connected and Induced methods of signal transfer.



MXT4 Transmitter

MXT4 Transmitter

The MXT4 Transmitter is designed for use with the MXL4 Locator.

- Automatic Daily Self Test.
- Data Logging of all Transmitter activity.
- Automatic Back-light.
- Four Power Output settings up to One Watt.
- Pulsed or Continuous output signal.
- Loud, Muted or Silent audible output settings.
- Six Frequency settings: 512Hz, 640Hz, 8kHz, 33kHz, CF (33kHz and 131kHz combined), 131kHz (HF).
- All Frequencies applicable using the Direct Connect method of signal transfer.
- 8kHz, 33kHz, CF (33kHz and 131kHz combined), 131kHz (HF) frequencies applicable using the Induced method of signal transfer.



Locator Operating Modes: Power Mode

In Power Mode the Locator detects power signals. These power signals are present on all current carrying electricity cables although not all are detectable. Power signals may also flow along other conductors such as metal gas and water pipes, telecom cables, metal fences and railway tracks.

Limitations of Power Mode

Not all electricity cables can be found using the Power Mode. Here are the most important examples of electricity cables that may not be detectable in the Power Mode:

- Street lighting cables. When the lights are off, no current flows and so no power signal is created.
- Supplies to buildings or plant using very little or no electricity may not have a detectable power signal.
- Pot-ended or capped cables. These will never have any current flowing through them but are possibly still live.
- Disused or abandoned cables.
- A few high voltage electricity cables. These can be 'well balanced', electrically and therefore radiate little or no power signal.
- Direct Current cables (such as those found on railway systems). These do not create their own Power signals.
- Cables more than 3m (9'9") deep.



NOTE Locators can only detect services radiating a detectable electromagnetic signal.

There may be some services that do not radiate these signals and cannot be located.

NOTE The absence of a power signal does not mean the service is not live.



WARNING Generally these services should be detectable using the Radio or Generator/Transmitter Modes.

Locator Operating Modes: Radio Mode

In Radio Mode, the Locator detects signals from various radio transmitters. These signals flow through the ground and will tend to follow the line of least resistance such as a buried metallic service. When this happens the service can often be detected by using the Locator in Radio Mode.

Limitations of Radio Mode

- Not all services will be detectable in Radio Mode.
- A strong radio signal present on one service may be masking a weaker radio signal present on an adjacent service.
- It is not normally possible to determine what the service is in Radio Mode, only its position.
- Radio signals do not favour one utility over another.
- The depth of the buried service cannot be judged by the strength of the radio signal alone.
- Normally it is only possible to detect radio signals present on services up to 2 m (6'6") deep.
- A short service may not have enough signal to be detected.



NOTE Locators can only detect services radiating a detectable electromagnetic signal. There may be some services that do not radiate these signals and cannot be located.



WARNING Most buried metallic services not found in Radio Mode should be detectable by using Generator Mode with the Signal Generator/Transmitter.

Locator Operating Modes: AllScan Mode

In AllScan Mode, the Locator detects at ALL frequencies in a wide band. Sometimes a signal that is outside of the frequency range of the other search modes (Power, Radio, and Generator/Transmitter) will be present on a buried metallic service. AllScan Mode is a useful additional search mode to employ as it may detect these 'extra' signals as well as the Power, Radio and Generator/Transmitter signals.

Using the AllScan Mode is also a good way to confirm the accuracy of the marking of metal pipes and cables previously detected using the Power, Radio and Generator/Transmitter modes of detection.

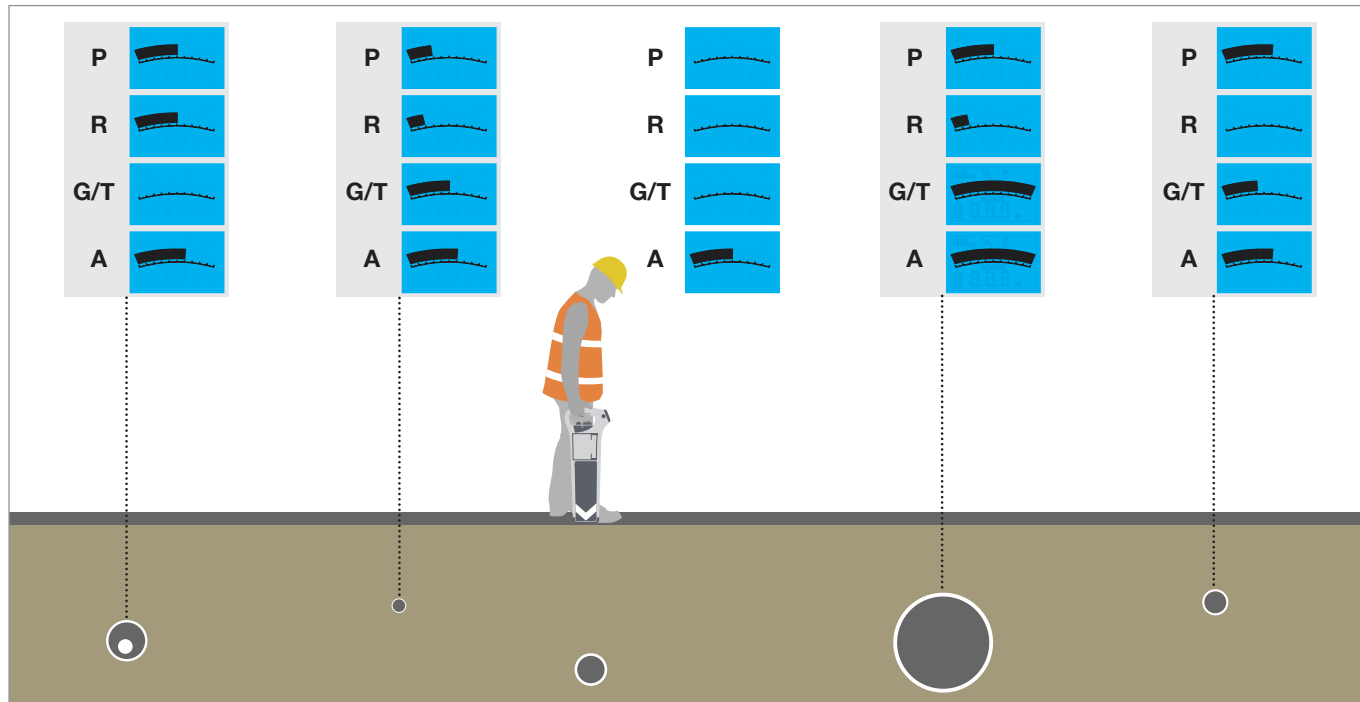

Locator Operating Modes: *All*Scan Mode

Limitations of *All*Scan Mode

*All*Scan Mode has exactly the same limitations as those listed for the Power and Radio Modes:

- Street lighting cables when the lights are switched off, supply cables to buildings or plant using little or no electricity, pot-ended or capped cables, well balanced high voltage cables and direct current cables may all be missed on the *All*Scan Mode.
- A strong *All*Scan signal present on one service may mask a weaker *All*Scan signal present on an adjacent service.
- It is not normally possible to determine what the service is in *All*Scan Mode, only its position.
- *All*Scan signals do not favour one utility over another.
- The depth of the buried service cannot be judged by the strength of the *All*Scan signal alone.
- Normally it is only possible to detect *All*Scan signals present on services up to 2 m (6'6") deep.
- A short service may not have enough signal to be detected.



WARNING Using the Power and Radio Modes may be more effective in areas where there are many services radiating an *All*Scan signal.

Locator Operating Modes: Generator/Transmitter Mode

In Generator/Transmitter Mode the Locator detects conductors radiating a signal applied by the Signal Generator/Transmitter or the signal radiated by a Sonde.

The Signal Generator/Transmitter provides a way of sending a known signal along buried metallic services which can then be detected using the Locator. By detecting this signal it is possible to locate, trace and identify the pipes or cables that may be carrying it.

There are TWO basic methods by which the Signal Generator/Transmitter signal can be applied to buried services:

- Direct Connection - The Signal Generator/Transmitter is attached directly to the service using either the Direct Connection Leads or one of the accessories available for use with the Signal Generator/Transmitter such as the Signal Clamp or Signal Injector.
- Induction - The Signal Generator/Transmitter can induce a signal onto a buried metallic service remotely from the surface without the need to physically connect to that service.

Limitations of Generator/Transmitter Mode are covered in the 'Using the Signal Generator/Transmitter' section of this Manual.

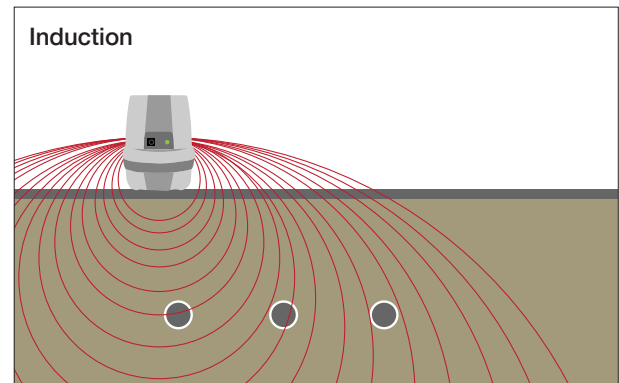
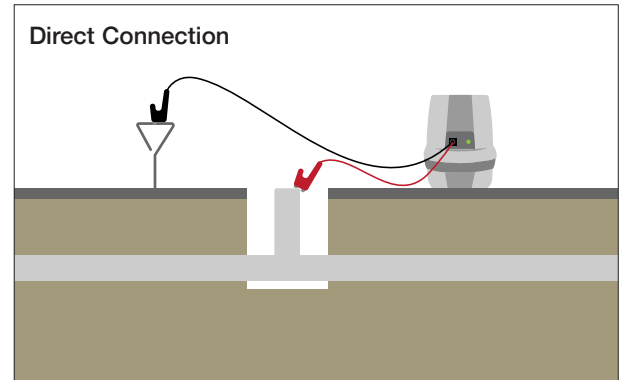

WARNING Locators can only detect services radiating a detectable electromagnetic signal. There may be some services that do not radiate these signals and cannot be located.

Using the Locator: Batteries

C.Scope Locators can be powered by either eight standard alkaline or Nickel-Metal Hydride rechargeable (NiMH) AA (LR6) size batteries.

Locator Battery Check

Switch the Locator on by pulling up on the On/Off trigger positioned on the underside of the handle. The Locator should emit a clear audible battery check tone for one second and the display should come on.

Check the battery level indicator in the bottom left hand corner of the display. If there is only one segment or no segments of the indicator filled in then the batteries will need to be replaced or recharged before locating work can begin.

Battery Levels OK

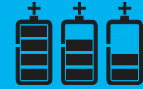

Replace or Recharge batteries



NOTE The Locator will carry out an automatic daily Self Test when it is switched on for the first time each day (see pages 12-13 for full details)

Changing Locator Batteries

- Push the two clips back to release the Battery Compartment door.
- Remove ALL EIGHT used batteries and replace with new or recharged ones.
- Be careful to insert the new batteries the correct way round in the holder.
- Replace the holder in the Battery Compartment making sure that the two terminals on the holder make contact with the two terminals within the Battery Compartment.
- Close the Battery Compartment door securely.



NOTE A spare battery pack can be carried inside the Battery Compartment.

NOTE Only use alkaline or Nickel-Metal Hydride rechargeable (NiMH) AA (LR6) size batteries.

NOTE Dispose of the used batteries safely in accordance with local regulations.



WARNING Do not change batteries in confined spaces where gas may be present.

WARNING Do not mix old and new or different types of batteries.

Using the Locator: Automatic Daily Self Test

The CXL4, DXL4 and MXL4 Locators have an in-built automatic Daily Self Test function. This tests the Locator's circuits and receiving aerials for correct performance.

The Self Test is automatically performed the first time the Locator is switched on each day and takes approximately four seconds.

i **NOTE** When turning the Locator on for the first time it is important that no other Locator is situated within 30cm (1') and that no Signal Generators, Transmitters or Sondes are operating within 5m (16') .

NOTE Try not to switch the Locator on for the first time in an area with unusually high Power signals such as next to an electricity transformer.

The Self Test process is indicated by 'TEST' appearing on the display. In the top left hand corner of the screen a countdown timer shows the progress of the test.

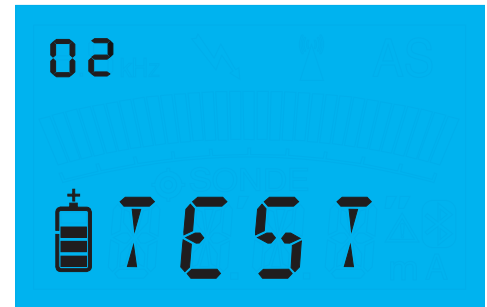

i **NOTE** The Locator records every Automatic Daily Self Test. The Test results can be retrieved from the Locator to produce a Product Validation Certificate by using the PC Toolkit (see page 57).

Using the Locator: Automatic Daily Self Test

After the Locator has successfully completed the Self Test the Locator is ready for use as per normal. It will not undertake another Self Test that day.

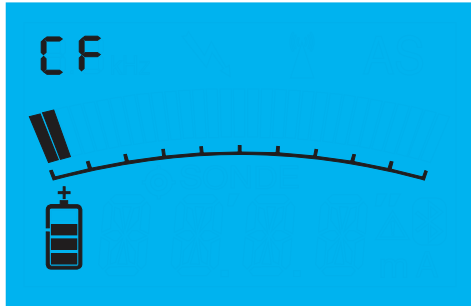

If the Locator has failed the Self Test the Warning symbol will appear in the bottom right hand corner of the screen.

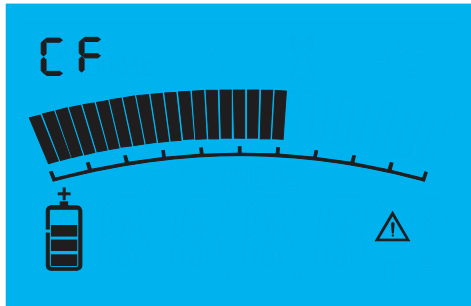

If the error code 'OVER' is displayed alongside the Warning symbol this indicates that there is a significant external signal present that has corrupted the actual Self Test process.

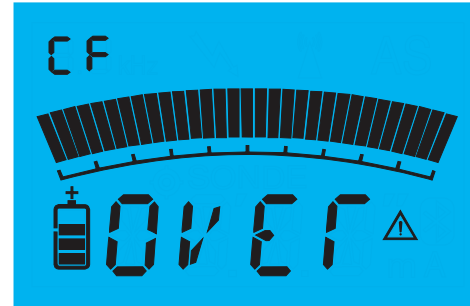

The source could be an active Signal Generator, Transmitter, Sonde or Locator or a nearby transformer or other power source emitting a strong Power mode signal.

In this situation make sure all nearby Signal Generators, Transmitters and Sondes are switched off or move a few metres/feet to a different location. The Locator will automatically initiate a new Self Test when it is next switched on and will continue to do this until a successful Self Test has been achieved.

If the Locator still fails a Self Test then this is indicating that there is a fault and the Locator should be withdrawn from service. Contact C.Scope or a C.Scope Authorised Service Centre for advice.

Using the Locator: Holding the Locator

When in use the Locator should always be held upright. Never swing the Locator such that it moves away from the vertical. The Locator will emit an audio warning if the Locator is being swung excessively.



Your middle or little finger should be used to squeeze, and hold on, the On/Off trigger. Your index finger will then be free to adjust the Sensitivity Control.

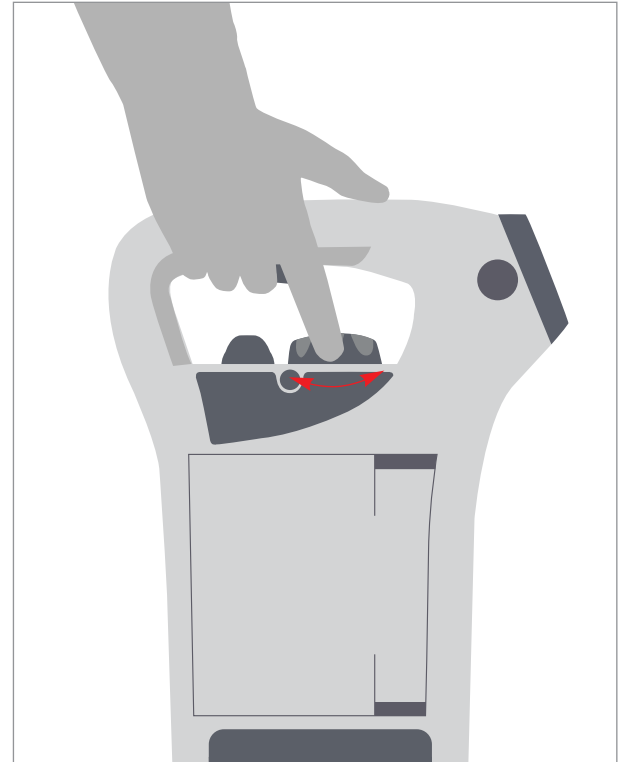

Using the Locator: Searching

There are three stages to the locating process; searching, pinpointing and tracing.

1. Turn the Mode Switch to the appropriate mode.
2. Hold in the On/Off trigger. The Locator should emit the audible battery test tone and the digital display should come on. Check the battery level indicator to confirm the batteries are usable.
3. Rotate the Sensitivity Control fully clockwise to its maximum setting as indicated by the arrow on the control.
4. Carry out the search using a grid pattern as shown in the diagram. Walk slowly and keep the Locator upright at all times and stationary by your side.
5. As you approach the area in which there is a signal the Locator will emit an audible response and show a visual response on the display.
6. Keep walking until the audible and visual responses disappear.

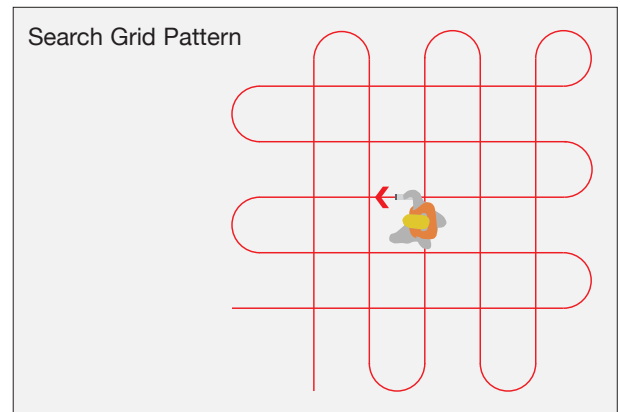

NOTE This search technique applies only to the Power, Radio and All Scan Modes.

See 'Using the Signal Generator/Transmitter' for the correct search pattern when using Generator/Transmitter Mode.

NOTE Sometimes the Locator will give an audible response and strong (full scale) visual response across the whole of the search area. In this case turn the sensitivity down slightly and repeat the search using the same grid pattern.

Using the Locator: Pinpointing

Having found a signal the next step is to pinpoint the source. The closer the Locator is to the signal source the stronger the response.

To Pinpoint a Signal

1. Keeping the Locator vertical, walk through the area of the signal response. If the visual response goes up off the scale then stop and reduce the sensitivity of the Locator slightly before continuing.
2. The width of the signal response will shrink as the sensitivity is reduced. Once it is reduced enough then a clear peak response will be seen on the display as the Locator traverses the service. The Locator is positioned directly above the buried service when the display is at its highest (peak) reading.

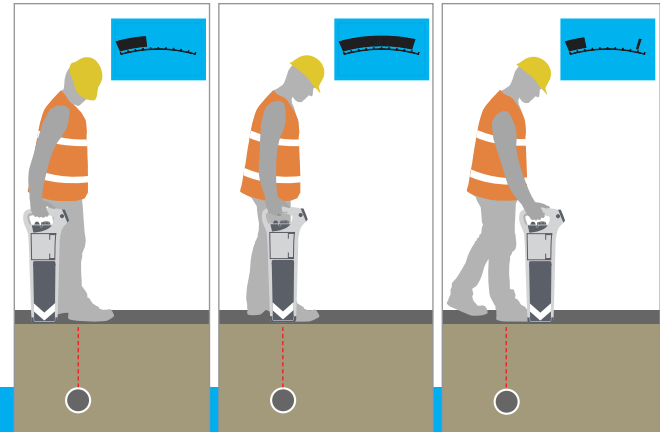

NOTE Each time the Locator response reaches its peak position, a single 'PeakHold' line will remain showing on the bar graph for two seconds to assist you to return to the correct peak position.

3. Carefully rotate the Locator over the peak reading until the visual response falls to a minimum. The Locator will now be roughly IN LINE with the direction of the buried service.



NOTE The presence of other signals in the immediate vicinity may result in the visual response not reducing to a minimum level when the Locator is rotated over the peak response.

4. Mark the position of the buried service.



NOTE The amount of sensitivity adjustment needed to pinpoint a service can vary depending on the mode being used, the signal strength and the service depth.

NOTE The word 'OVER' will appear on the display if the Locator is detecting a signal that is too strong. This is irrespective of which mode of detection is being used and can also be caused if the Power Output setting on the Signal Generator/Transmitter is too high.

Using the Locator: AlarmZone™

The CXL4, DXL4 and MXL4 Locators feature an AlarmZone™ which is a form of automated depth measurement intended to alert the user to the presence of unusually shallow pipes or cables.

The AlarmZone™ warning will be triggered if the Locator measures a Power, Generator/Transmitter or A//Scan signal as being less than 0.3m (12") away. The Locator will give an audible alert and the AlarmZone™ warning symbol will flash on the display of the Locator.



NOTE The Locator is measuring the distance from the base of the Locator to the source of the signal (the metal pipe or cable). If the Locator is held a significant distance above the ground surface then it may not trigger an AlarmZone™ warning because the Locator is now too far away from that shallow service.

The AlarmZone™ depth setting is shown each time the Locator is switched on.

The AlarmZone™ is factory set to be triggered at 0.3m (12"). This distance can be altered using the PC Toolkit.

The AlarmZone™ feature can be temporarily disabled by switching between the Generator/Transmitter mode and A//Scan mode three times in quick succession. If you have disabled the AlarmZone™ feature, each time the Locator is switched on the display will read 'OFF'.

AlarmZone™ will remain disabled for 30 minutes at which point it will be automatically reactivated.

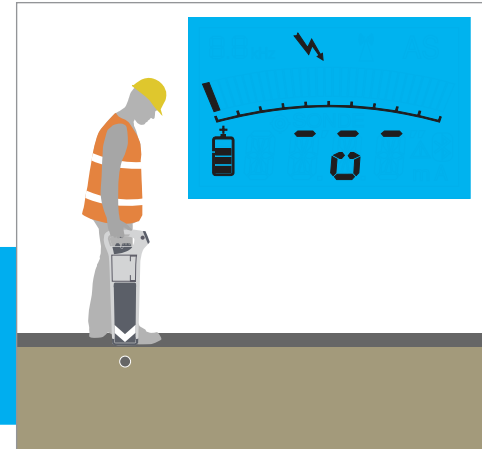

WARNING There may be some pipes and cables that are not radiating a signal so the AlarmZone™ warning will not appear. NEVER presume there are no shallow pipes or cables present simply because AlarmZone™ has not been triggered.

Using the Locator: Tracing

Having pinpointed a service it should now be possible to trace its route.

1. Carefully follow the direction of the signal holding the Locator at right angles to the line of the signal. It is necessary to constantly 'slice' the Locator from side to side in order to be sure of still being over the peak signal response.
2. Stop and mark the position of the signal at regular intervals. As more marks are recorded the precise direction of the service will become more apparent.

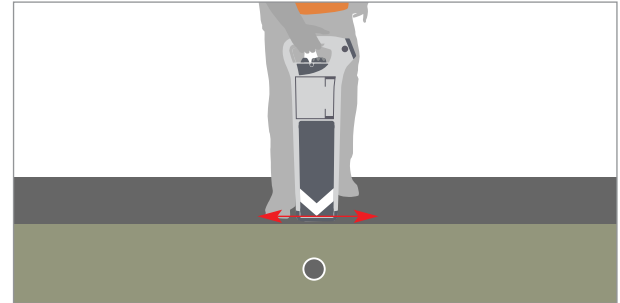

NOTE It may be necessary to readjust the sensitivity to maintain the optimum response.

NOTE After tracing, return to the original search grid to search for further buried services.



WARNING Never rush the tracing process. Small and unexpected changes in the service's route will be missed if care is not taken to follow the signal's path every step of the way.

Lost Signals

This can be because of a curve, or bend in the route, change in depth of the service, a T connection or the end of the service.

Finding Lost Signals

1. Walk in a circle at least 1 m (3'3") around the point where the signal was lost. This should locate the service if the signal has been lost because of a curve or bend in the route of the service, or a T connection into another service.
2. If you find nothing then increase the sensitivity and repeat the circle. This should find the service if it has continued but at a greater depth.

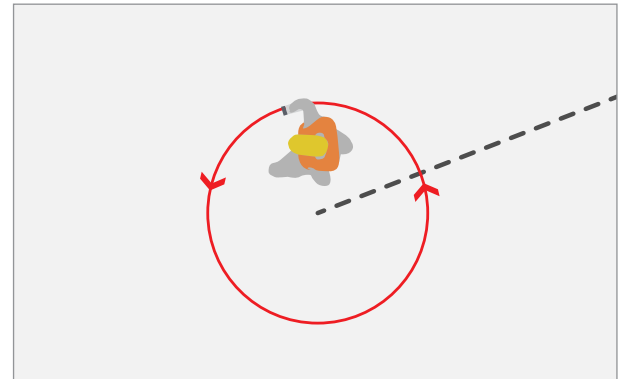

Using the Signal Generator/Transmitter

Using the Locator in Power and Radio Modes will only allow you to locate and mark the position of buried services that are producing a Power signal or re-radiating a Radio signal.

Use of the Signal Generator/Transmitter should enable most, if not all, of the remaining buried metallic services to be detected and traced. This section explains the various ways in which the Signal Generator/Transmitter can be used.

It also shows how to use those accessories that allow the Signal Generator/Transmitter to be directly connected to specific services.

Direct Connection - Physically connecting the Signal Generator/Transmitter to a service is the most effective way to transfer the signal onto that service and the best way to trace the route of that service.

Signal Clamp - The Signal Clamp is an accessory that allows the Signal Generator/Transmitter signal to be applied to a specific cable without having to make electrical contact with that cable. Although the Signal Clamp is not physically fixed to the cable we still consider it as a Connection method because it is using the Signal Generator/Transmitter in Connection Mode.

Signal Injector - The Signal Injector is an accessory that allows the Signal Generator/Transmitter signal to be safely applied to an electrical system via a conventional 3-pin power socket. This signal will then be detectable on the buried supply cable outside the building.

Induction - Induction is a method of applying a signal to a service to which there is no direct access.



NOTE The Locator should always be handled and operated according to the instructions shown in the 'Using the Locator' section unless specifically shown otherwise in this section.

NOTE SGA4 Signal Generators will always switch on at higher power output, continuous signal and loud audio setting.

NOTE SGV4 Signal Generators and MXT4 Transmitters will switch on to the last used settings.

NOTE SGV4 Signal Generators and MXT4 Transmitters have a display backlight that is activated each time any control button is pressed. The display will remain illuminated for 15 seconds.

Using the Signal Generator/Transmitter: Output Power Level and Pulse/Continuous Output

Output Power Level

The SGV4 Signal Generator and the MXT4 Transmitter have four, selectable output power levels. The SGA4 Signal Generator has two selectable output power levels.

For long distance tracing or for detecting deep services it is always best to use the highest power setting of the Signal Generator/Transmitter. Please note, however, that higher power settings will drain the batteries more quickly than lower power settings.

For tracing work close to the signal application point, especially when using Induction Mode, the lower power settings are better.



NOTE When using accessories such as the Signal Clamp, Signal Injector, Plastic Pipe Tracers and Flexible Tracer it is normally best to use the highest power setting.

Pulsed/Continuous Output

For most locating work a Continuous signal output is best and **MUST** be used for any Depth or Signal Current Measurements.

A Pulsed signal output can be useful when it has become difficult to distinguish the Signal Generator/Transmitter signal from unwanted interference, for example, when tracing services over long distances or at greater depths.

Using the Signal Generator/Transmitter: Frequency Selection (*MXT4 only*)

Select the frequency on the MXT4 Transmitter and the MXL4 Locator by pressing the Frequency (f) buttons. The Frequency (f) buttons will scroll through the various frequency options in order.

Generally, the Combined Frequency (CF) is the best frequency setting to use as it performs well in many applications. CF is a combination of 33kHz and 131kHz.

The lower frequency signals 512Hz, 640Hz and 8kHz should travel further along a metallic service although they may be more difficult to successfully apply in the first place. There should also be less 'coupling' of these lower frequency signals onto adjacent services.

The highest frequency setting, 131kHz (HF), is likely to be most successful when attempting to detect and trace short length or poorly earthed cables.

There can be exceptions to these general rules, and so often the best option is to try each frequency setting and then utilise the one that is giving the best results for that particular service. This is irrespective of the method of signal application; Direct Connection, Signal Clamp, Signal Injector or Induction Mode, and of the service being traced.



NOTE The 512Hz and 640Hz frequency signals can only be applied using the Direct Connection Leads.



WARNING The Locator frequency **MUST** always be set to the same frequency setting as the Transmitter.

Using the Signal Generator/Transmitter: Batteries

C.Scope Signal Generators/Transmitters can be powered by either four standard alkaline or by four standard Nickel-Metal Hydride rechargeable (NiMH) D (LR20) size batteries.

Signal Generator/Transmitter Battery Check

SGA4 Signal Generator

Switch the SGA4 on by pressing the On/Off Control. The SGA4 should emit a loud continuous tone. An interrupted tone will be heard if the batteries need replacing or recharging immediately.

If the batteries need replacing during use, the same interrupted tone will be heard, and the signal output will also be interrupted.

SGV4 Signal Generator and MXT4 Transmitter

Switch the SGV4/MXT4 on by pressing the On/Off Control.
Check the battery level indicator in the bottom left hand corner of the display.

If there is only one segment or no segments of the indicator filled in it is advisable to replace or recharge the batteries before locating work begins.

If 'FLAT' appears on the display, the unit will cease to transmit any signals and the batteries must be replaced or recharged.

Battery Levels OK



Replace or Recharge batteries

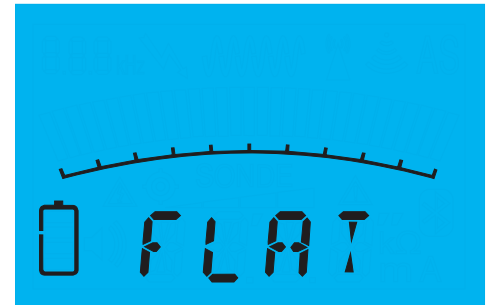

NOTE The Signal Generator/Transmitter will carry out an automatic daily Self Test when it is switched on for the first time each day (see pages 24-25 for full details).

Using the Signal Generator/Transmitter: Batteries

Changing the Batteries

- Remove the Accessory Tray.
- Undo the two round knurled battery cover retaining screws situated on the underside of the Signal Generator/Transmitter.
- Remove ALL FOUR used batteries and replace with new ones.
- Be careful to insert the new batteries the correct way round in the compartment as indicated on the case.
- Replace the Battery Cover being careful to not over tighten the retaining screws.
- Replace the Accessory Tray.



NOTE Only use alkaline or Nickel-Metal Hydride rechargeable (NiMH) D (LR20) size batteries.

NOTE Dispose of the used batteries safely in accordance with local regulations.



WARNING Do not change batteries in confined spaces where gas may be present.

WARNING Do not mix old and new or different types of batteries.

Using the Signal Generator/Transmitter: Automatic Daily Self Test (SGV4 and MXT4 only)

The SGV4 and MXT4 have an in-built automatic Daily Self Test function. This tests the Signal Generator/Transmitter circuits and transmitting aerials for correct performance.

The Self Test is automatically performed the first time the Signal Generator/Transmitter is switched on each day and takes approximately twelve seconds.

The Self Test process is indicated by 'TEST' appearing on the display.



NOTE A Self Test can be initiated manually by holding down the Pulse/Continuous button while the Signal Generator/Transmitter is switched on.

NOTE The SGV4 and MXT4 record every Automatic Daily Self Test and any manual Self Test. The Test results can be retrieved from the Signal Generator/Transmitter to produce a Product Validation Certificate by using the PC Toolkit (see page 58).

Using the Signal Generator/Transmitter: Automatic Daily Self Test (SGV4 and MXT4 only)

If the Signal Generator/Transmitter has successfully completed the Self Test, 'PASS' will appear on the display. The Signal Generator/Transmitter is ready for use as per normal. It will not undertake another automatic daily Self Test that day.

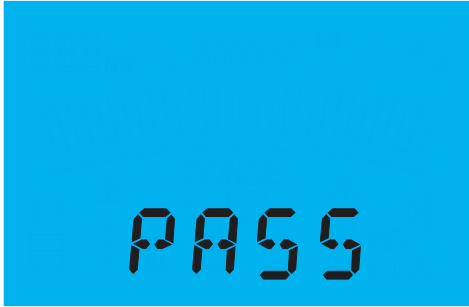

If the Signal Generator/Transmitter has failed the Self Test, 'FAIL' will appear on the display and the Self Test warning symbol will flash. The Self Test warning symbol will then remain on the display.

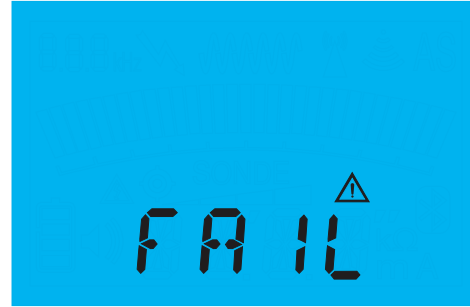

After any Self Test fail, the Signal Generator/Transmitter will automatically initiate a new Self Test when it is next switched on.

If the Signal Generator/Transmitter fails a Self Test it should be withdrawn from service. Contact C.Scope or a C.Scope Authorised Service Centre for advice.

Using the Signal Generator/Transmitter: Direct Connection



WARNING Never connect directly to electrical services.

WARNING You may need to seek permission from the service owners before connecting on to some buried services.

The Direct Connection Leads and Earth Stake that are supplied with the Signal Generator/Transmitter are used to apply a signal to any metal pipe at a suitable access point such as a valve, hydrant point, stop cock or exposed pipe length.

1. Plug the Direct Connection Leads into the Signal Generator/Transmitter Connection Socket.
2. Attach the red lead to the pipe at your point of access using the Crocodile Clip. Ensure that you have a secure and clean grip on the pipe with the Crocodile Clip.
3. Turn the Signal Generator/Transmitter on.

For MXT4 only, select frequency to be used; 512Hz, 640Hz, 8kHz, 33kHz, CF, 131kHz (HF).

4. Place the Earth Stake in the ground (having first searched the area for buried services with the Locator).

The ideal position for the Earth Stake is at right angles to the assumed line of the pipe and the full length of the Direct Connection Leads away from the pipe access point.

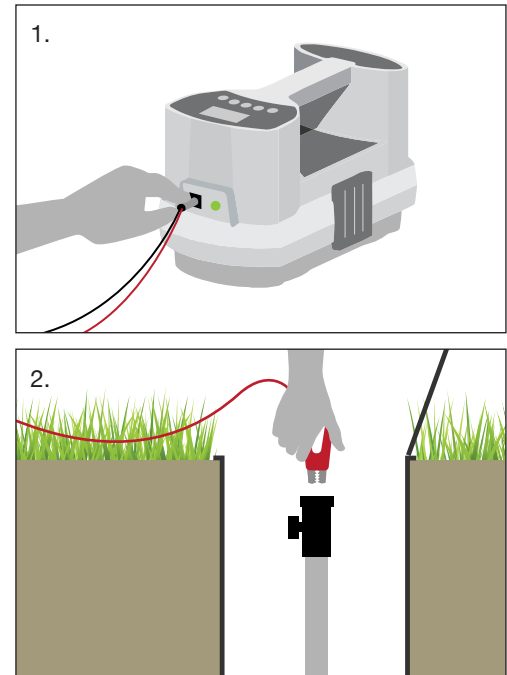

NOTE The type of metal that the pipe is constructed from or its use will have little effect on its traceability.

NOTE If it is not possible to get the Crocodile Clip to grip the pipe then use the Magnet supplied.

NOTE SGV4 Signal Generators and MXT4 Transmitters will switch on to the last used settings.

Using the Signal Generator/Transmitter: Direct Connection

5. Connect the black Earth Lead to the Earth Stake (or an alternative earth point). If your earth point is too far away from the pipe access point for the black Earth Lead to reach then use the yellow 10 metre Auxiliary Earth Lead instead.

6. As the Earth Lead is connected to the Earth Stake the audible signal from the Signal Generator/Transmitter should change in pitch. The lower the pitch, the better the signal will be on the metal pipe.

If there is no change in pitch it may be that some dirt, rust or paint on the pipe is preventing the Crocodile Clip or Magnet from making a good contact with the pipe. Alternatively it may be that your earth point is at fault. Change the position of the Earth Stake or use an alternative earth point.

For SGV4 and MXT4 only, there will be a visual representation of the quality of the connection in addition to the audible pitch change. The greater the response on the display, the better the signal will be on the pipe.

7. Adjust the Output Power Level to suit.

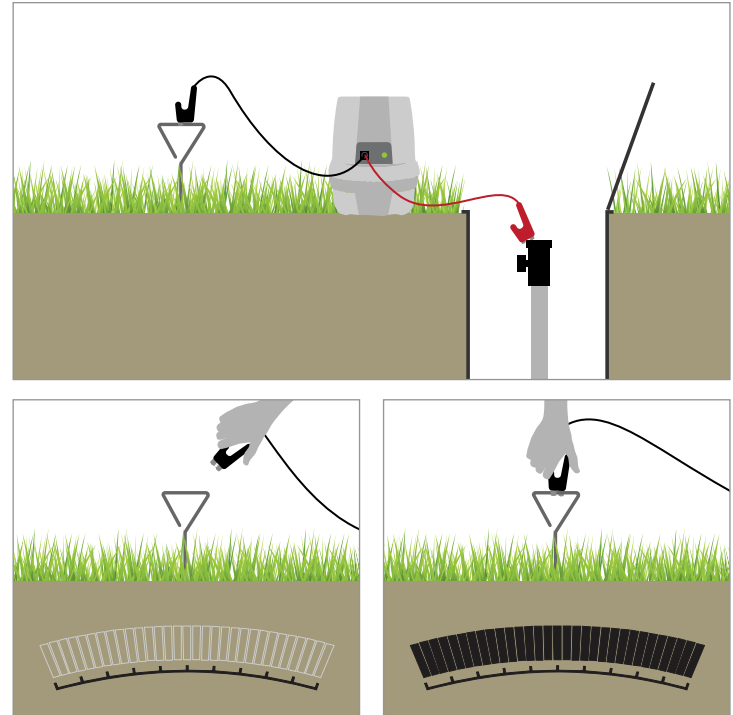

NOTE If it is not possible to use the Earth Stake use a nearby metal fence post, manhole cover or gully cover.

NOTE If the Earth Stake cannot be inserted into the ground then simply laying it flat on the ground can sometimes provide a successful earth connection (especially if the ground is wet).

DO NOT use something that may have another metallic service attached to it, such as a metal street lighting column.

NOTE If the Signal Generator/Transmitter pitch does not change then there is no signal being transferred onto the service.

Using the Signal Generator/Transmitter: Direct Connection to street furniture

Direct Connection to a Street Lighting Column or other street furniture

The best method to determine the position and route of street lighting, car park lighting cables or any other item of street furniture with a power supply is by using a Signal Generator/Transmitter and the pipe connection method.

Follow the same rules as for connecting the Signal Generator/Transmitter to a metal pipe except attach the red Direct Connection Lead to a metal part of the OUTSIDE of the lamp column/ street furniture.

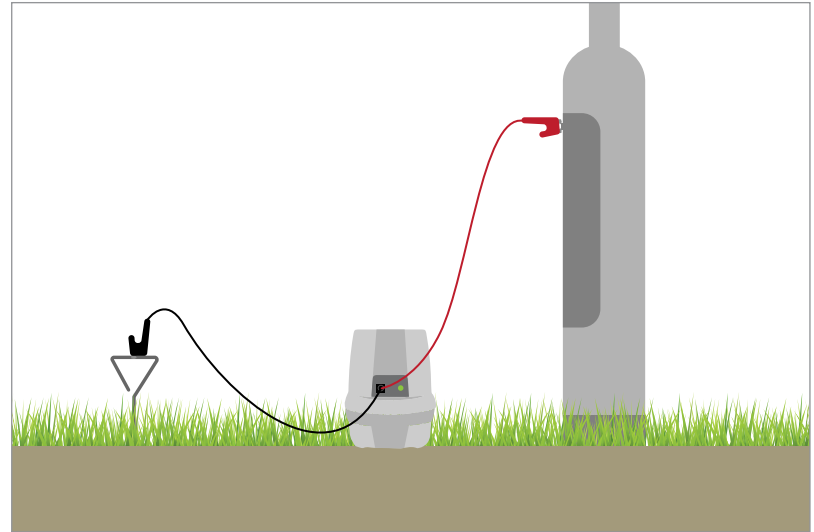

WARNING NEVER open the lamp column door to gain access to the cables, this is potentially dangerous and is not necessary.



NOTE Make sure that the Direct Connection Crocodile Clip or Magnet is not insulated from the metal of the column by paint.
NOTE If the column is concrete attach the Crocodile Clip or Magnet to the metal surround of the access door.

Using the Signal Generator/Transmitter: Signal Hopping (SGV4/MXT4 only)

Signal Hopping using Direct Connection Leads

If it is difficult or inconvenient to use the Direct Connection method of signal application then an alternative technique called Signal Hopping can be utilised to successfully energise a street lighting or car park lighting cable with the Signal Generator/Transmitter signal.

Wrap the red Direct Connection lead around the street lighting column (two or three times if possible). This is particularly useful if it is difficult to get a good metal to metal connection between the Crocodile Clip or Magnet and the column.

The black Direct Connection lead is connected to the Earth Stake positioned away from the column.

For MXT4 Transmitter only, ensure 131kHz (HF) or CF frequency setting is selected.

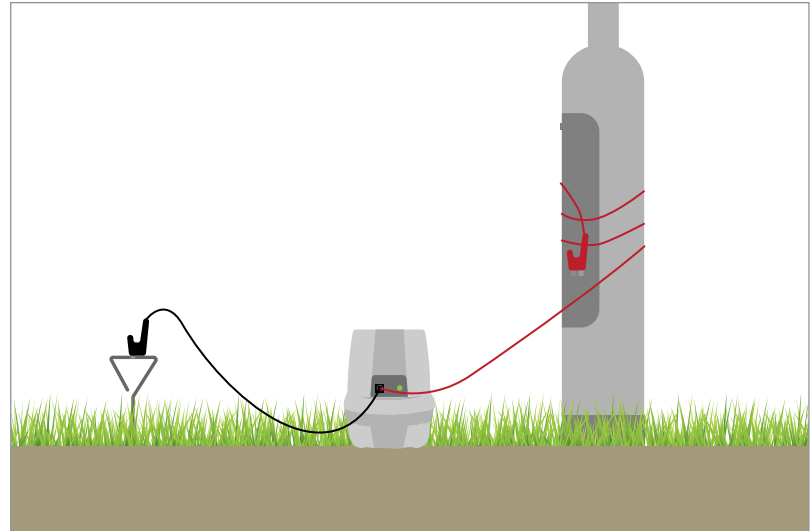

NOTE If the Earth Stake cannot be inserted into the ground then simply laying it flat on the ground will often provide a successful earth connection when using the Signal Hopping technique.

Using the Signal Generator/Transmitter: Signal Clamp

Signal Clamp

1. Plug the Signal Clamp into the Connection Socket on the Signal Generator/Transmitter.
2. Turn the Signal Generator/Transmitter on.

For MXT4 only, select either 8kHz, 33kHz or CF frequency.

3. Check that the jaws of the Signal Clamp are clean. Place the Signal Clamp AROUND the cable making sure that the jaws are able to fully close. The audible signal from the Signal Generator/Transmitter should drop in pitch indicating that the jaws have closed correctly.

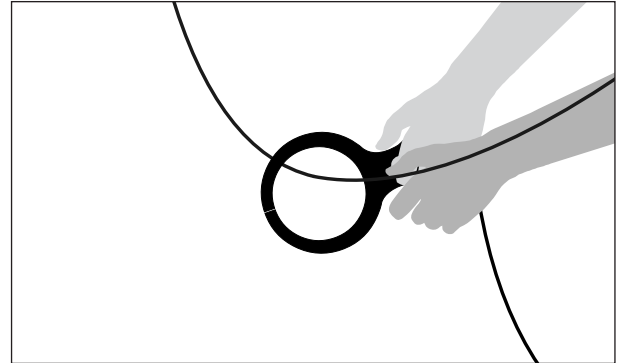

WARNING NEVER attempt to place the Signal Clamp around electricity cables that are deliberately suspended out of reach. They may be unsheathed or unprotected cables.



NOTE The Signal Clamp cannot apply a signal to a cable that is not earthed at both ends such as abandoned cables that have been cut off where they appear above ground or cables supplying unearthed equipment.

Using the Signal Generator/Transmitter: Signal Injector

Signal Injector

1. Plug the Signal Injector into the Connection Socket on the Signal Generator/Transmitter and an electric outlet.
2. Turn the Signal Generator/Transmitter on.

For MXT4 only, select either 8kHz, 33kHz or CF frequency.

3. Turn the socket on. The audible tone from the Signal Generator/Transmitter will drop in pitch to indicate a successful connection.

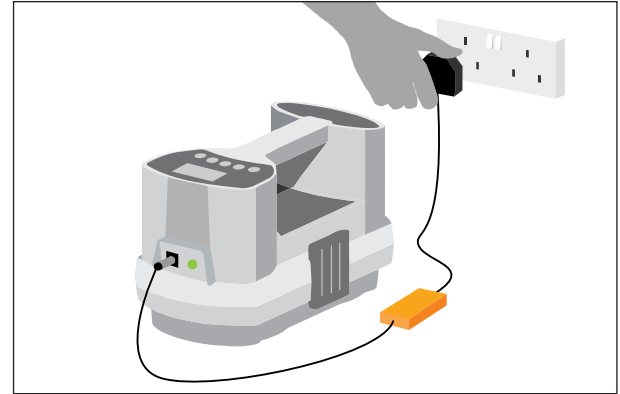

NOTE On two wire Protective Multiple Earth (PME) systems it may be necessary to also provide an external earth using the yellow 10 metre Auxiliary Earth Lead and Earth Stake.

NOTE Using the Signal Injector may cause the system protection to trip.

NOTE Always check with the owners that it is acceptable to interrupt the supply before connecting the Signal Injector.



WARNING DO NOT use the Signal Injector on systems with voltages in excess of 240 volts AC. Domestic systems will normally be below this voltage.

Using the Signal Generator/Transmitter: Searching for the Direct Connected Signal

The search pattern used to find the Signal Generator/Transmitter signal when applied by a direct connection method (Direct Connection Leads, Signal Clamp or Signal Injector) is different to the normal search pattern used on Power, Radio or All/Scan Modes.

1. Move a few paces away from where the Signal Generator/Transmitter has been connected to the service. Turn the Mode Switch to Generator/Transmitter Mode. Hold the Locator so that the side of the Locator is facing towards the Signal Generator/Transmitter. *For MXT4 only, ensure that the Transmitter and Locator are set to the same frequency.*
2. Adjust the Locator sensitivity so it shows a minimal visual response and emits a minimal audible response.
3. If possible walk in a complete circle around the connection point trying to keep the same distance from this point at all times. When a signal is detected, 'pinpoint' that signal as shown in the 'Using the Locator' section.
4. Having pinpointed the first signal, do not adjust the Sensitivity Control but continue with the circle to see if any other signals are detected. If more signals are detected compare the strength of each signal by observing the bar display. The strongest signal will usually be coming from the service that the Signal Generator/Transmitter is connected to.

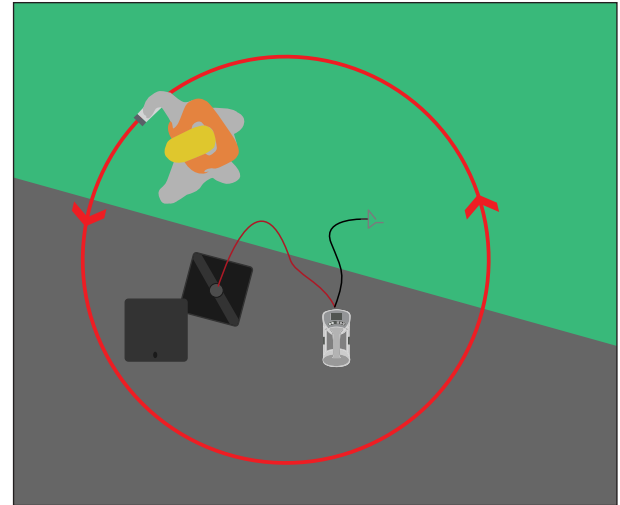

Using the Signal Generator/Transmitter: Tracing the Direct Connected Signal

The tracing technique used to follow the Signal Generator/Transmitter signal when applied by a direct connection method (Direct Connection Leads, Signal Clamp or Signal Injector) is almost exactly the same as the normal tracing technique used on Power, Radio or All/Scan Modes, except the signal the Locator is detecting will get weaker the further away from the Signal Generator/Transmitter that you go. It will be necessary to regularly increase the Locator Sensitivity Control to compensate for this.

For MXT4 only, having traced the signal for a short distance it may be worthwhile switching the MXT4 Transmitter to alternative frequencies to see if they give a stronger response. Choose the frequency that gives the strongest response and continue with the trace.

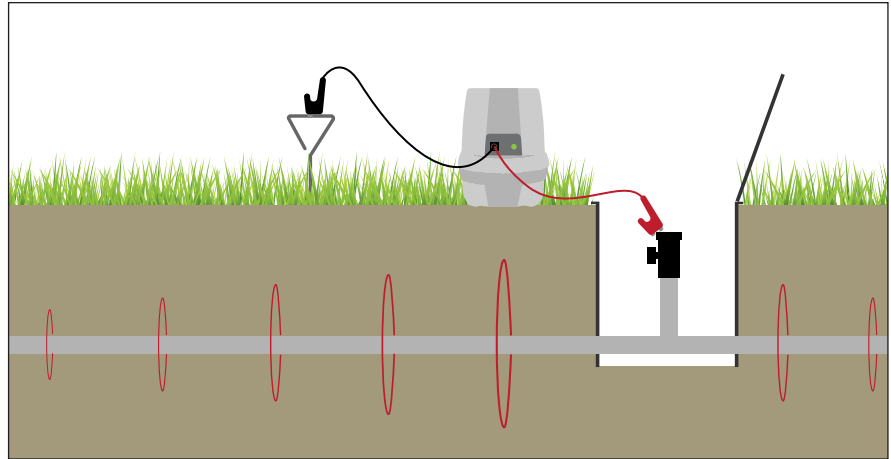

NOTE It is not possible to search for the signal above any leads connecting the Signal Generator/Transmitter to the service or above the Earth Lead connected to the Earth Stake.

Using the Signal Generator/Transmitter: Induction

This is the standard method for inducing signals onto buried metallic services. It produces a strong signal directly below the Signal Generator/Transmitter but the signal strength drops off quite quickly either side of the Signal Generator/Transmitter.

1. Check that there are no accessories plugged into the Connection Socket. The Signal Generator/Transmitter switches automatically to Induction Mode when the socket is unused.
2. Place the Signal Generator/Transmitter upright on the ground where you suspect the services are buried. Make sure the Signal Generator/Transmitter is in line with the expected route of these services.
3. Turn the Signal Generator/Transmitter on and check that the batteries are OK.

For MXT4 only, select 8kHz, 33kHz, CF or 131kHz (HF). It is not possible to induce a 512Hz or 640Hz signal onto buried services.

4. The signal will be radiated into the ground immediately below and for approximately 3m (10') either side of the Signal Generator/Transmitter.

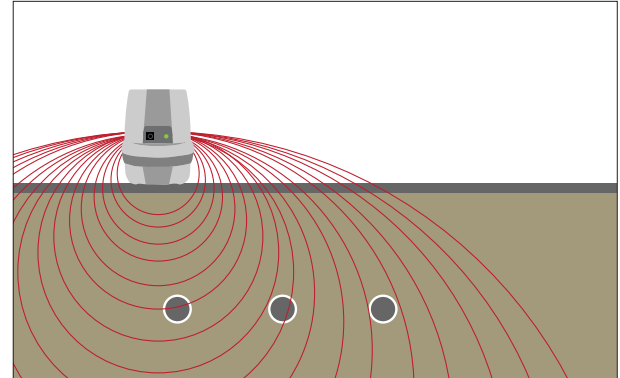

NOTE The closer the Signal Generator/Transmitter is to the position of the buried service then the stronger the signal will be on that service.

NOTE Only metallic services that are approximately in line with the Signal Generator/Transmitter orientation will be energised with a signal. Metallic services that are crossing the line of the Signal Generator/Transmitter will NOT be energised.

Using the Signal Generator/Transmitter: Searching for an Induced Signal

The search pattern used to find the Signal Generator/Transmitter signal when applied by Induction Mode is slightly different to the search pattern used on other modes.

1. Move AT LEAST 10m (33') away from the Signal Generator/Transmitter position with your Locator. This is to avoid the Locator picking up the airborne signal rather than the signal induced onto the buried service.
2. Stand so that you are roughly in line with the end of the Signal Generator/Transmitter and hold the Locator so that the side of the Locator is facing towards the Signal Generator/Transmitter.
3. Select Generator/Transmitter Mode.

The MXL4 Locator must be set to the same frequency as the MXT4 Transmitter.

4. Adjust the sensitivity so that the Locator shows a minimal visual response and emits a minimal audible response.

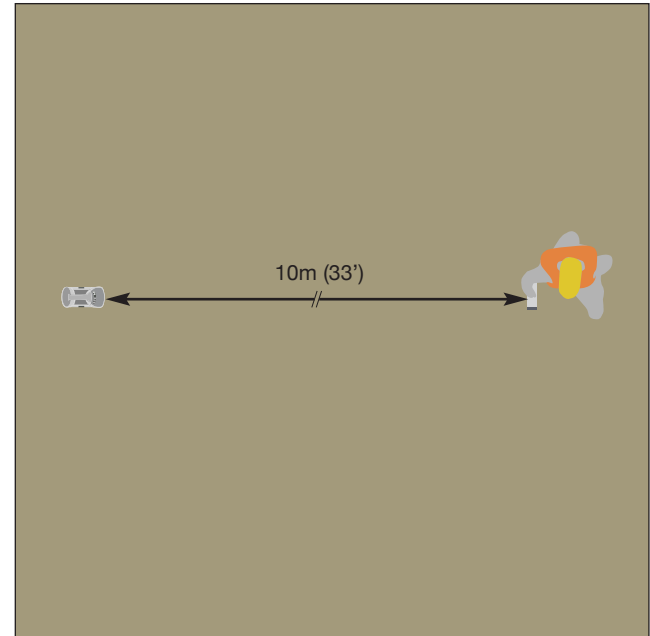

NOTE A Signal Generator/Transmitter will transmit a significant amount of signal into the air as well as into the ground. Keep the Locator upright at all times to reduce the risk of picking up the airborne signal.

Using the Signal Generator/Transmitter: Searching for an Induced Signal

5. Walk in a straight line across the end line of the Signal Generator/Transmitter. When a signal is detected 'pinpoint' that signal as shown in the 'Using the Locator' section.

If no signal is found move the Signal Generator/Transmitter 5 m (16') and try again. Continue this procedure moving the Signal Generator/Transmitter in 5 m (16') steps, following a grid pattern, until a signal can be found.

6. It may be possible to increase the strength of the induced signal on the buried service by improving the positioning of the Signal Generator/Transmitter. Once the buried service has been pinpointed, moving the position of the Signal Generator/Transmitter from side to side will give an increase or decrease in the Locator response. Remember, the closer the Signal Generator/Transmitter is to the position of the buried service then the stronger the signal will be on that service.

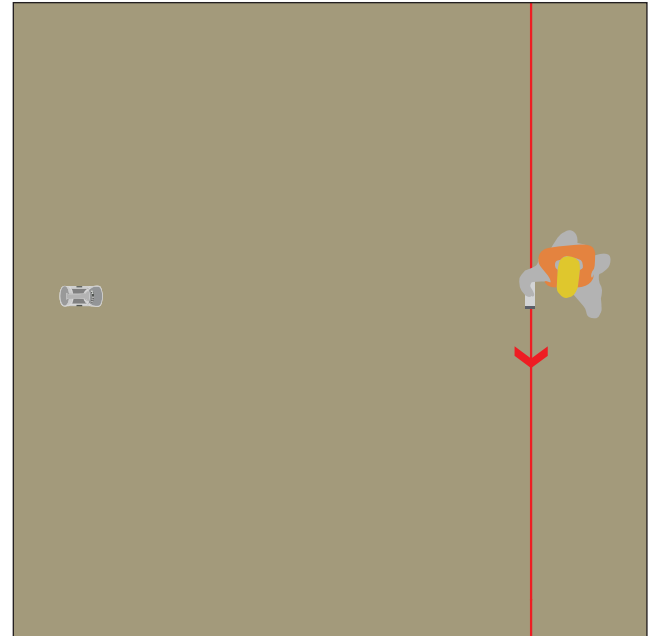

NOTE The Signal Generator/Transmitter signal that the Locator is detecting will get weaker the further away from the Signal Generator/Transmitter that you go. It will be necessary to regularly increase the sensitivity to compensate for this.

Using the Signal Generator/Transmitter: Induction: Multiple Services

It is important to check for the presence of adjacent services running close, or parallel, to the service that you have already located.

1. Check that there are no accessories plugged into the Connection Socket.
2. Turn the Signal Generator/Transmitter on and check that the batteries are OK.
3. Place the Signal Generator/Transmitter on the ground on one side over the previously located service. That service will not have a signal induced onto it.
4. Re-scan the area looking for another peak signal close to where the original signal was found. This operation should be repeated until you are satisfied that no further services can be located.

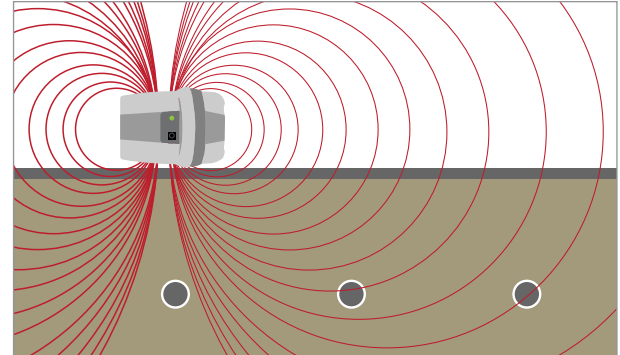

NOTE The signal will be radiated up to 3 m (9'9") either side of the Signal Generator/Transmitter but NOT directly below when the Signal Generator/Transmitter is on its side.

Limitations of Induction Method - There are limitations concerning what can be achieved when using a Signal Generator/Transmitter on the Induction Mode compared to the Connected Mode. It is not normally possible to identify what the service is that has been detected with an induced signal. If the signal can be followed far enough, a visible feature such as a valve cover or cable pit cover may be found that can indicate the identity of the service.

Cables with a very small cross section may not have enough signal induced onto them to make them detectable. It is often not possible to apply an induced signal onto just ONE specific buried service, in order to trace it alone, when other services are positioned in a close proximity.



NOTE An induced signal cannot be applied to a buried service that lies beneath reinforced concrete. The reinforcing bars will re-radiate the induced signal masking any signal that has been induced onto the buried service below.

Using the Signal Generator/Transmitter: Inductive Sweep

If a large area needs to be searched for buried services then an 'Inductive Sweep' could be used. It is an ideal method for detecting the position of buried services as they cross the boundary of a large site.

An Inductive Sweep requires two people; one to operate the Locator and one to position the Signal Generator/Transmitter.

1. Stand about 10 m (33') apart.
2. The first person holds the Signal Generator/Transmitter, switched to it's lowest Output Power Level, close to the ground and 'end on' (see diagram) whilst the other holds the Locator switched to Generator/Transmitter Mode.
3. Adjust the sensitivity so that the Locator shows a minimal visual response and emits a minimal audible response.
4. Together, slowly walk across the site, staying the same distance apart and being careful to keep in line with each other. When the Signal Generator/Transmitter gets close to a buried metallic service the signal will be induced onto it and you should see this in the increased response on the Locator.
5. Immediately tell your colleague to stop and place the Signal Generator/Transmitter on the ground at that point. Now you can pinpoint the service and trace out it's route. Continue the sweep across the length and width of search area.

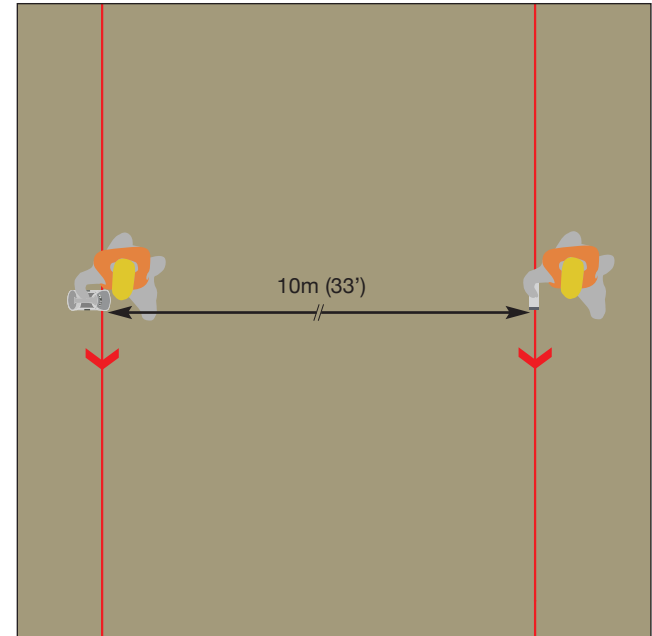

NOTE It is important to maintain the same distance and between the Locator and Signal Generator/Transmitter at all times.
NOTE Only metallic services that are approximately in line with the Signal Generator/Transmitter orientation will be energised with a signal. Metallic services that are crossing the line of the Signal Generator/Transmitter will NOT be energised.

Non-Metallic Pipe Tracing

Non-metallic pipes such as sewers or drains, service ducts, plastic gas and water pipes are not electrically conductive and so will not be detectable using a Locator on Power, Radio or *All* Scan Modes. It is also impossible to apply a detectable Signal Generator/Transmitter signal to the non-metallic pipe or, for that matter, to the water or gas within that pipe.

If access can be gained into the pipe then a C.Scope Sonde, Plastic Pipe Tracer or Flexible Tracer should make it possible to determine the pipes position and route.

Sondes

The C.Scope 8kHz and 33kHz General Purpose Sondes and the Duct Sonde are small, battery powered, waterproof transmitters that can be inserted into a pipe, such as a sewer, drain or cable duct. The position of the Sonde (and therefore the location of the pipe) can be pinpointed by using the Locator switched to Generator/Transmitter Mode.

The Sonde is inserted into and then moved along the pipe to the point at which the pipe needs to be located. This is normally done by fitting the Sonde to drain rods. Alternatively, the Sonde can be attached to a continuous fibreglass duct rodder, jetter hose or camera inspection system.

- The 33kHz General Purpose Sonde can be used in pipes as small as 50mm (2") in diameter and up to 7m (23') deep.
- The 33kHz Duct Sonde can be used in pipes as small as 30mm (1.1") in diameter and up to 5m (16') deep.
- The 512Hz and 640Hz Metal Pipe Sondes are able to transmit a signal from within a metal pipe. They can be used in pipes as small as 50mm (2") in diameter. The maximum depth the Metal Pipe Sonde can be detected will depend on the pipe material and wall thickness.



NOTE An 8kHz or 33kHz Sonde will NOT transmit a signal through a metal pipe.

Non-Metallic Pipe Tracing: Sonde Batteries

General Purpose Sonde and Metal Pipe Sonde

The General Purpose Sonde is available in two frequencies; 33kHz (orange casing) or 8kHz (green casing) and is powered by a single standard alkaline or Nickel-Metal Hydride rechargeable (NiMH) AA (LR6) size battery.

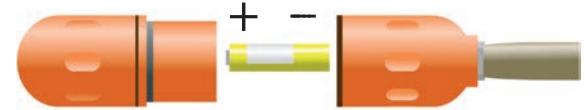

The Metal Pipe Sonde (red casing) is available in two frequencies; 512Hz and 640Hz, and is powered by a single alkaline AA (LR6) size battery. The frequency of the Sonde is indicated on the label within the battery compartment.

The 8kHz General Purpose Sonde and 512Hz or 640Hz Metal Pipe Sondes can only be used with the MXL4 Locator.

1. To turn the Sonde on, separate the two halves of the Sonde casing. Insert a new battery into the battery compartment with the positive end down.
2. Screw the two halves of the Sonde together being careful not to over tighten them. The Sonde is now transmitting a signal.
3. To turn the Sonde off the battery must be removed or reversed.



NOTE Only use an alkaline or Nickel-Metal Hydride rechargeable (NiMH) AA (LR6) size battery.

NOTE Dispose of the used battery safely in accordance with local regulations.

NOTE Always use a new battery in a Sonde if you expect to take a long time to trace the pipe or duct route.



WARNING The Locator must always be set to Generator/ Transmitter Mode when using the Sonde.

For the MXL4 Locator, the correct frequency must also be selected.

Non-Metallic Pipe Tracing: Duct Sonde Batteries

33kHz Duct Sonde

The Duct Sonde (yellow casing) transmits at 33kHz and is powered by a single AAA (LR03) size alkaline battery. Rechargeable batteries are not recommended for this product.



1. To turn the Duct Sonde on, use a large flat bladed screwdriver to unscrew the battery cover located within the hollow end of the Sonde casing. Insert a new battery into the battery compartment with the positive end down.
2. Replace the battery cover fully using the screwdriver to secure. The Duct Sonde is now transmitting a signal.
3. To turn the Sonde off the battery must be removed.



NOTE Only use an alkaline battery.

NOTE Dispose of the used battery safely in accordance with local regulations.

NOTE Always use a new battery in a Sonde if you expect to take a long time to trace the pipe or duct route.



WARNING The Locator must always be set to Generator/ Transmitter Mode when using the Sonde.

For the MXL4 Locator, the correct frequency must also be selected.

Non-Metallic Pipe Tracing: Tracing a Sonde

The technique used to determine the position of a Sonde is always the same irrespective of which Sonde is being used.

Before inserting the Sonde into the pipe it is best to set up the Locator so that the Sensitivity is correctly adjusted to suit the pipe depth. This is much easier to do when the Sonde is visible at the bottom of the manhole rather than already some distance up the pipe.

The blade of the Locator must be held **IN LINE** with the Sonde at all times.



NOTE This is at 90° to the way in which the Locator is held for most other locating tasks.

1. Turn the Locator to Generator/Transmitter Mode and switch on. *For the MXL4 Locator, the correct frequency must also be selected.* Check the Battery Level Indicator to confirm the Locator batteries are usable. Replace if necessary.
 2. Keeping the blade of the Locator in line with the Sonde, move the Locator **backwards and forwards** over the length of the Sonde. Adjust the Sensitivity until a clear peak response is shown on the display as the Locator passes directly over the position of the Sonde.
- Still keeping the blade of the Locator in line with the Sonde, now move the Locator from **side to side** over the position of the Sonde. A similar peak response should be seen on the display as the Locator passes directly over the position of the Sonde. The Locator is now set up ready for tracing the Sonde.
3. Push the Sonde up the pipe.

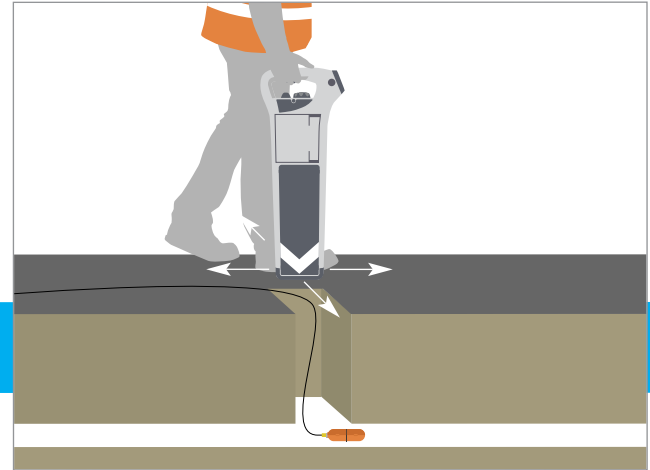

Non-Metallic Pipe Tracing using a Sonde: Tracing a Sonde

4. With the Locator turned on, walk from the pipe access point in the direction that the Sonde was pushed. A strong peak signal directly over the Sonde should be detected with two lesser 'ghost' signals found, one in front of and one behind the Sonde's true position. These ghost signals are always weaker than the main signal and should not be mistaken for the true Sonde signal.

5. Pinpoint the Sonde's exact position by moving the Locator first backwards and forwards and then from side to side to get the peak response on both occasions.

6. Push the Sonde further up the pipe and repeat the pinpointing process.

See page 48 for depth measurement using a Sonde.

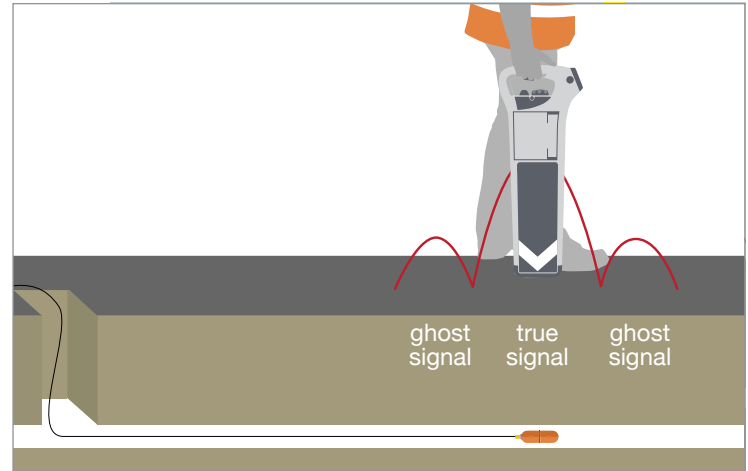

Non-Metallic Pipe Tracing: Plastic Pipe Tracers/Flexible Tracer

The Plastic Pipe Tracers and Flexible Tracer can be used in small diameter non-metallic pipes that normal Sondes cannot fit into. Two methods of detecting and tracing can be used: line tracing and end tracing.

For **Line Tracing**, the Plastic Pipe Tracer needs to be inserted into the pipe before a signal from the Signal Generator/Transmitter is applied to the length of the Tracer. The slip-ring mechanism of the Flexible Tracer allows the Signal Generator/Transmitter to be connected before it is inserted into the pipe.

The 33kHz, CF or HF Signal Generator/Transmitter signal is applied using the 'Direct Connection to a metal pipe' method. Connect the red Direct Connection Lead to the red terminal of the Plastic Pipe Tracer/ Flexible Tracer. Connect the black lead to the Earth Stake. Leave the other terminal of the Plastic Pipe Tracer/ Flexible Tracer unconnected.

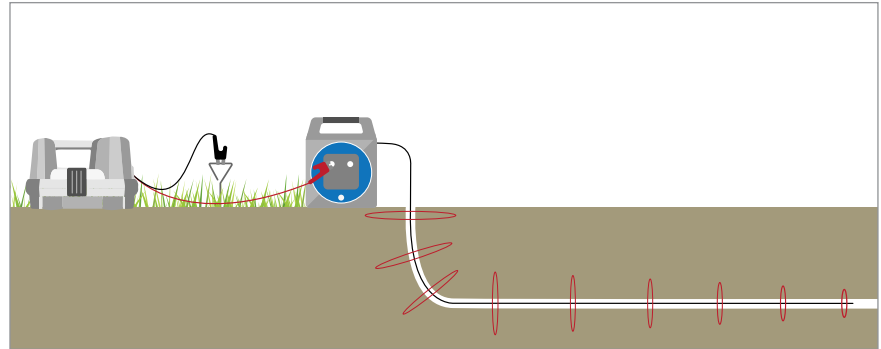

WARNING Authorisation may be required before using the Plastic Pipe Tracer/ Flexible Tracer on some pipes or ducts.



NOTE It is important that a change of pitch is heard when making the connections to ensure that there is a detectable signal present on the Tracer.

NOTE The Signal Generator/Transmitter signal is unlikely to travel the entire length of the Tracer within the pipe. Never assume that you have located the end of the Tracer on Line Tracing Mode. Use End Tracing if required.

NOTE The Plastic Pipe Tracer and Flexible Tracer can be used inside a metal pipe or duct but the signal will transfer onto the pipe or duct itself.

Non-Metallic Pipe Tracing: Plastic Pipe Tracers/Flexible Tracer

End Tracing

The very tip of the Plastic Pipe Tracer/ Flexible Tracer can be energised with the signal from a Signal Generator/ Transmitter. It is acting much like a Sonde and offers a very reliable way of pinpointing the position of the tip. Pipes and ducts up to 4 m (13') deep can be traced.

The Signal Generator/Transmitter signal is applied by connecting the red Direct Connection Lead to the red terminal on the Tracer and the black Earth Lead to the other terminal. As the second connection is made a change of pitch should be heard from the Signal Generator/Transmitter signal indicating successful connection.

For MXT4 only, select 33kHz or CF frequency.

The tip of the Plastic Pipe Tracer/ Flexible Tracer is then pinpointed using the same technique as for Sonde tracing with the Locator blade always in line with the Tracer.

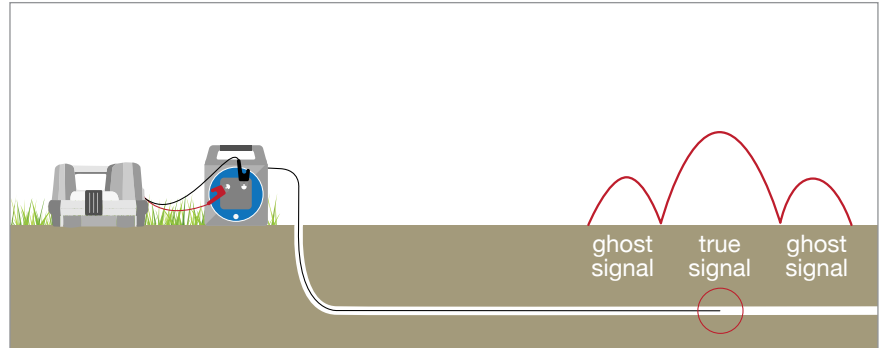

WARNING Authorisation may be required before using the Plastic Pipe Tracer/ Flexible Tracer on some services.



NOTE It is important that a change of pitch is heard when making the connections to ensure that there is a detectable signal present on the Tracer.

NOTE End Tracing is the ideal method to determine where the end of the pipe is but does not give the route of the pipe.

NOTE The Plastic Pipe Tracers and Flexible Tracer do not work on End Tracing mode when inside a metal pipe or duct.

Depth Measurement: Metallic Services (DXL4 and MXL4 Locators only)

The DXL4 and MXL4 Locators can be used in conjunction with the Signal Generator/Transmitter, Sonde, Plastic Pipe Tracer or Flexible Tracer to indicate the depth of a buried service.

Depth cannot be measured on the Power, Radio or AllScan Modes.

For the MXL4 Locator, depth measurements can be taken from a 512Hz, 640Hz, 8kHz, 33kHz, CF or HF (131kHz) signal.



WARNING The depth indication **MUST NOT** be used to decide if mechanical digging over the buried service is appropriate.

WARNING If the following procedure for Depth Measurement is not followed then an inaccurate depth may be indicated. This is worse than having no depth information at all.

1. The Signal Generator/Transmitter must be set to 'Continuous' signal output, not 'Pulsed' output.
2. It is vital that the signal being measured is a good quality signal. This is best achieved by using the Signal Generator/Transmitter in Connected Mode rather than Induced Mode.
3. Set the Locator to Generator/Transmitter Mode and pinpoint the position of the buried service. Make sure the Locator is directly over, and at right angles to the route of, the buried service. Rest the Locator on the ground with the body vertical.

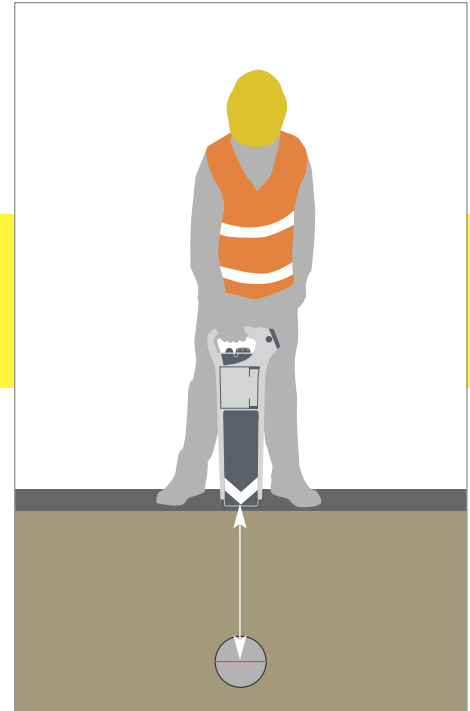

WARNING If the pinpointing of the service is inaccurate then the Depth Measurement will be inaccurate.



NOTE A poor quality signal is indicated by an unstable visual response on the Locator. Depth Measurement may be inaccurate in these circumstances.

Depth Measurement: Metallic Services (*DXL4 and MXL4 Locators only*)

4. Press and hold down the depth button. The depth will be shown on the display.
5. The depth can be verified by lifting up the Locator whilst keeping the depth button depressed. The depth indication should increase by the same amount that the Locator has been raised.

Limitations of Depth Measurement

There are some situations where it is not possible to gain accurate depth information:

- A curve or bend in the route of the service.
- Close to where the service changes in depth.
- Near to a 'T' junction in the service.
- At the very end point of a service.
- At any point where the signal has coupled onto an adjacent service.
- Close to any large metallic objects such as metal fences or vehicles.
- Within 25 m (82') of the position of the Signal Generator/ Transmitter if used on Induction Mode.
- Under reinforced concrete.
- The signal is of poor quality.
- Too close to the Signal Generator/ Transmitter or leads if used in Connected Mode.

Depth Measurement: Error Readings of Metallic Services

The Locator may show the following error codes when attempting a Depth Measurement:

1. 000 - The metallic service is too shallow for the Locator to obtain an accurate depth, less than 0.1m (4"). It should be possible to calculate the depth by raising the Locator a set amount and then carrying out the Depth Measurement again. The '000' Error will also display if the signal is not strong enough for the Locator to give a reliable depth measurement.
2. 888 - The metallic service is too deep for the Locator to measure its depth or there is no signal present.
3. OVER - Overload. The signal is too strong for the Locator to give a reliable depth measurement.

Note: Metric MXL4 pictured

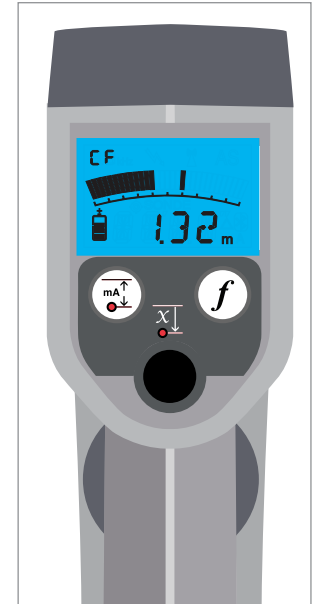

NOTE The depth shown will be to the centre of the service and is not the depth of cover.

This is of greater significance on large diameter pipes. Reading is to the nearest 0.01m.

NOTE AlarmZone™ will activate if the service is too close to the Locator. To measure shallow depths turn AlarmZone™ off temporarily as described on page 17.

Depth Measurement: Non-Metallic Pipes using Sondes/Plastic Pipe Tracers/Flexible Tracer (*DXL4 and MXL4 Locators only*)

i NOTE The following instructions apply equally to all Sondes, Plastic Pipe Tracers and the Flexible Tracer in End Tracing Mode.

1. Pinpoint the exact position of the Sonde or Plastic Pipe Tracer/Flexible Tracer tip. Take care to ensure that you are not over one of the two 'ghost' signals in front of and behind the true position.
2. Rest the Locator on the ground, keeping it vertical and IN LINE with the Sonde or Tracer tip.
3. **IMPORTANT. Push the depth button TWICE and hold on the second push, to select Sonde Depth Mode.** The word 'SONDE' will flash on the display and the depth will then be displayed (see picture). If the word 'SONDE' is not displayed then the depth reading will be inaccurate.

i NOTE The depth shown is that of the Sonde and NOT of the pipe.

Depth Measurement: Error Readings of Non-Metallic Pipes using Sondes/Plastic Pipe Tracers/ Flexible Tracer

The Locator may show the following error codes when attempting a Depth Measurement to a Sonde or the tip of a Plastic Pipe Tracer or Flexible Tracer:

1. 000 - The Sonde/Plastic Pipe Tracer/ Flexible Tracer is too shallow for the Locator to obtain an accurate depth, less than 0.1m (4"). It should be possible to calculate the depth by raising the Locator a set amount and then carrying out the Depth Measurement again. The '000' Error will also display if the signal from the Sonde/Plastic Pipe Tracer/ Flexible Tracer is not strong enough for the Locator to give a reliable depth measurement.
2. 888 - The Sonde/Plastic Pipe Tracer/ Flexible Tracer is too deep for the Locator to measure its depth or there is no signal at all present.
3. OVER - Overload. The signal from the Sonde/Plastic Pipe Tracer/ Flexible Tracer is too strong for the Locator to give a reliable depth measurement.

i NOTE AlarmZone™ will activate if the Sonde/Plastic Pipe Tracer/Flexible Tracer is too close to the Locator. To measure shallow depths turn AlarmZone™ off temporarily as described on page 17.

Note: Metric MXL4 pictured

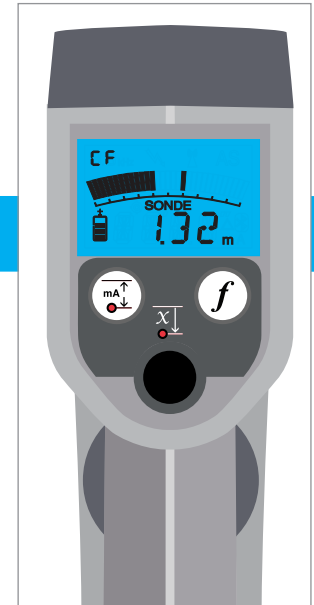

Signal Current Measurement (MXL4 Locator only)

For MXL4 Locator only, Signal Current Measurement is a feature by which it is possible to measure the TRUE strength of the MXT4 Transmitter signal on a buried metal pipe or cable irrespective of depth. This is a useful aid for the correct identification of specific pipes and cables and may also help to determine the layout and condition of a pipe or cable network.

When the Transmitter has been connected to a particular "target" service, the Locator may not always show the strongest response over that service. If the target pipe or cable happens to be much deeper than other services, which have picked up some of the Transmitter signal, these other services may show similar responses. However, the Signal Current reading will invariably be highest on the target pipe or cable therefore aiding correct identification.

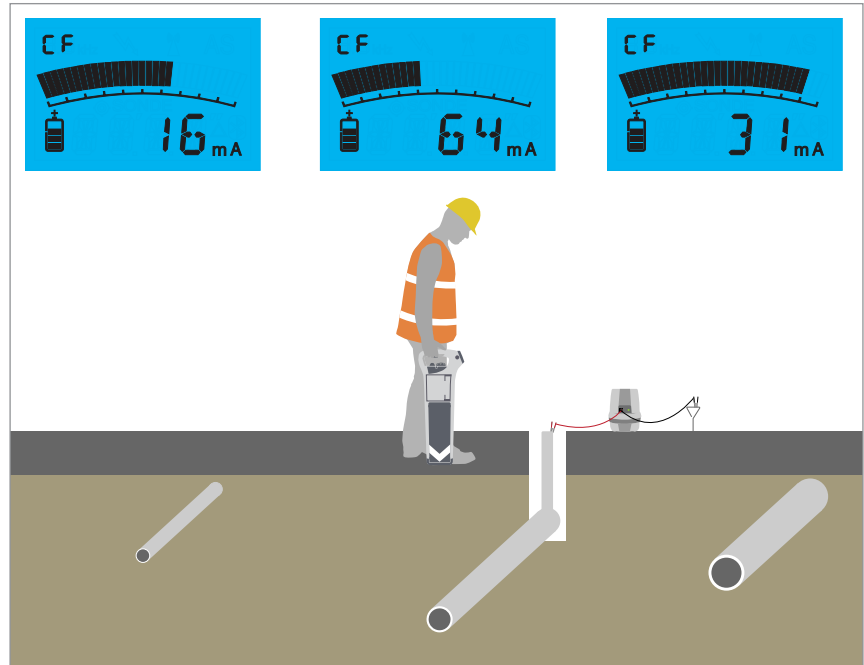

Signal Current Measurement (*MXL4 Locator only*)

Signal Current Measurement can also help to identify the layout of pipe and cable networks as the main line after a 'T' will have most of the Signal Current remaining on it whereas the shorter connection will have correspondingly less.

The Signal Current reading should also reduce at a uniform rate as the distance from the Transmitter increases. A sudden drop in Signal Current, in a short distance, indicates a change to that service such as an unknown connection, an insulated joint or a break in the pipe or cable.

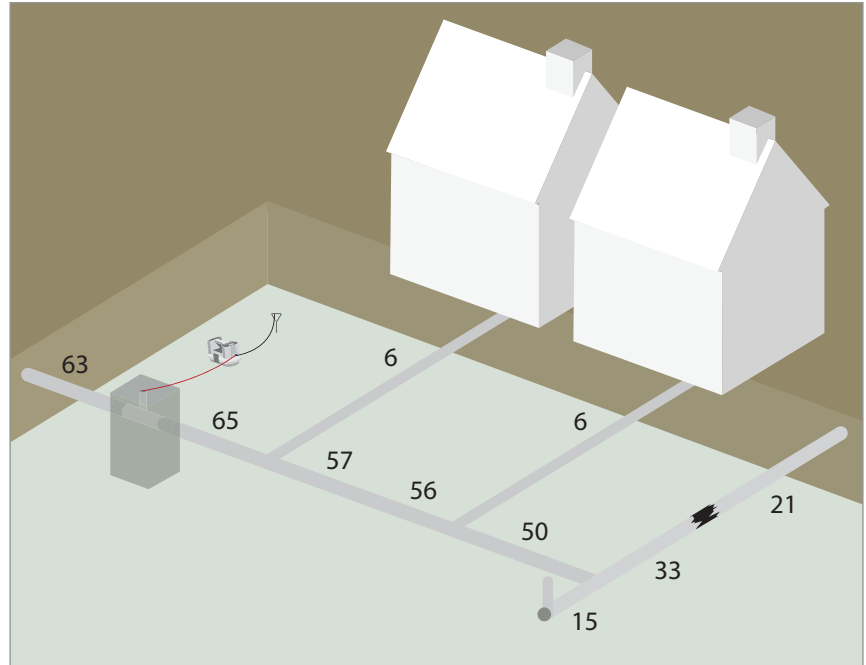

Signal Current Measurement (MXL4 Locator only)

To ensure reliable Signal Current readings it is vital to adhere to the same best practises as are used to give accurate Depth Measurement readings.

1. Only apply the signal by a Connection method (Direct Connection, Signal Clamp or Signal Injector) to the target service.
2. The Transmitter must be set to Continuous signal output, NOT Pulsed output.
3. Set the Locator to Transmitter Mode, select the correct frequency and pinpoint the position of the buried service. Make sure the Locator is directly over the buried service and at right angles to it's route. Rest the Locator on the ground with the body vertical.
4. Press and hold down the Signal Current button. The Signal Current reading will be shown on the display, measured in mA.

Allow the Signal Current reading to stabilise.

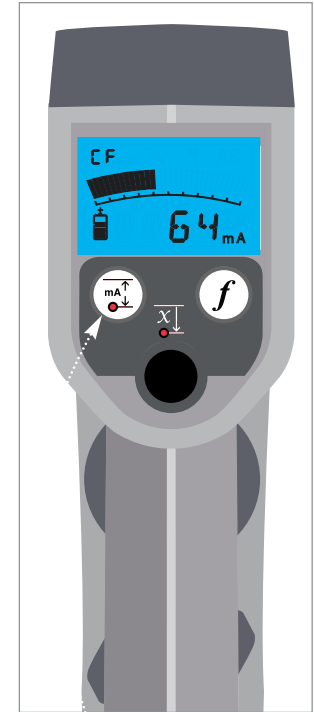
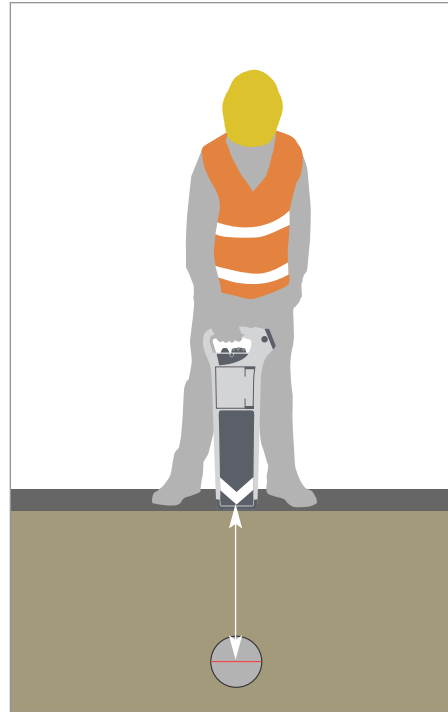

Signal Current Button



NOTE The Signal Current figure alone does not provide any useful information. It is how this figure compares to other Signal Current readings taken on other services or at different points along the target service that can indicate the layout and identity of the network.

Signal Current Measurement (*MXL4 Locator only*)

Limitations of Signal Current Measurement

There are some situations where it may not be possible to gain an accurate Signal Current Measurement reading:

- *At a sharp curve or bend in the route of the service.*
- *At a T junction in the service.*
- *At the very end point of the service.*
- *Close to any large metallic objects such as metal fences or vehicles.*
- *Within 25 m (82') of the position of the Transmitter.*
- *If the signal is of poor quality.*

Locator: Function Checks

The CXL4, DXL4 and MXL4 Locators have an in-built Self Test feature that automatically tests the Locator's circuits and receiving aerials for correct performance each day (see pages 12-13).

If you wish to carry out additional checks or to test the Locator's functionality more than once a day then the following procedures can be used:

Battery Condition

Check the Locator battery condition by depressing the On/Off Switch beneath the handle.

The display will show at least two solid segments if the batteries are OK. Ensure power on tone is heard.

Power Mode

Select Power Mode. Set sensitivity fully clockwise and point the base of the Locator at a fluorescent light from a distance of 1 m (3'). Switch the light on. A loud tone should be heard and the display should read greater than 50% full scale. Reducing the sensitivity should cause the displayed reading to reduce and the tone to cut out.

Radio Mode

Select Radio Mode. Set the sensitivity fully clockwise and, from a distance of less than 0.25m (10"), point the base of the Locator at a metal conductor of length greater than 100 m (330'), for example a metal pipe or cable. A warbling tone should be heard. The display should read greater than 50% full scale.

All Scan Mode

Select All Scan Mode. Repeat the same tests that were used to function check the Power and Radio Modes.



NOTE These Function Checks are approximate only. If a deterioration in performance is suspected for any reason, the equipment should not be used. It should be returned to C.Scope or a C.Scope Authorised Service Centre for more thorough investigation.

Locator: Function Checks

Generator/Transmitter Mode

Locate an outdoor test area that is free from overhead and underground cables and metal pipes.

The area should also not be near fences, steel framed buildings, or on reinforced concrete.

Place the Signal Generator/Transmitter on the ground and switch on - a tone should be heard.

Set to Continuous and ensure lowest Output Power is selected. *For the MXT4 Transmitter, set to CF frequency.*

With the Locator in the orientation shown, select Generator/Transmitter Mode. *For the MXL4 Locator, set to CF frequency.*

Rotate sensitivity fully clockwise. The results in the table below should be indicated.

Reducing the sensitivity should cause the displayed reading to reduce and the tone to cut out.

For the MXL4 Locator only, repeat with both Transmitter and Locator set to 8kHz. The results should be the same.

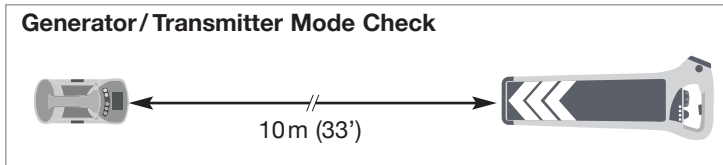

DISTANCE	MODE	AUDIO	METER
6 m (20')	Generator/Transmitter	Present	Full scale
24 m (80')	Generator/Transmitter	Less than at 6m (20')	Less than Full scale



NOTE These Function Checks are approximate only. If a deterioration in performance is suspected for any reason, the equipment should not be used. It should be returned to C.Scope or a C.Scope Authorised Service Centre for more thorough investigation.

Signal Generator/Transmitter: Function Checks

The SGV4 Signal Generator and MXT4 Transmitter have an in-built Self Test feature that automatically tests the Locator's circuits and transmitting aerials for correct performance each day (see pages 24-25). A Self Test can also be initiated manually by holding down the Pulse/Continuous button while the Signal Generator/Transmitter is switched on.

If you wish to carry out additional checks or to test the Signal Generator/Transmitter functionality more than once a day then the following procedures can be used:

Battery Condition

Turn the Signal Generator/Transmitter on and check batteries are in good condition (see pages 22-23). Replace or recharge batteries if necessary.

Induced Mode

This can only be checked in conjunction with a Locator as described on the previous page. If the unit does not meet the performance expected, repeat the test with another Locator to determine whether the Signal Generator/Transmitter is at fault.

Connected Mode

Set the minimum Output Power Level, insert the Direct Connection Lead and the 10 metre Auxiliary Earth Lead and then connect the red lead Crocodile Clip to the Auxiliary Earth Lead Crocodile Clip. The pitch should change to a low tone.

The leads should be arranged to create an open loop on the ground of approximately 1m (3') in diameter. Check that a signal can be detected by the Locator in Generator/Transmitter Mode when pointed closely at the loop.



NOTE These Function Checks are approximate only. If a deterioration in performance is suspected for any reason, the equipment should not be used. It should be returned to C.Scope or a C.Scope Authorised Service Centre for more thorough investigation.

Locators: Depth Measurement Function Checks (*DXL4 and MXL4 only*)

An area clear of services and metal structures should be chosen (beware of reinforced concrete car parks). A search with the DXL4 or MXL4 in all modes will help confirm the absence of other services. An insulated cable or wire (not supplied) over 20 m (70') long is laid out on the ground and the far end connected to a ground stake and earthed. The near end is connected to the red Direct Connection Lead.

The black Earth Lead should be laid at right angles to the 20 m (70') cable and earthed at the far end with the Earth Stake. The plug should be inserted in the Direct Connection Socket of the Signal Generator/Transmitter.

The Signal Generator/Transmitter is turned on to the lowest Output Power Level and Continuous Mode. The Locator should then be held vertically above the longer cable, approximately midway along it and the depth can then be measured. It is best to make a few readings at different depths. *For MXL4 Locators only, this procedure can then be repeated using 512Hz, 640Hz or 8kHz.*

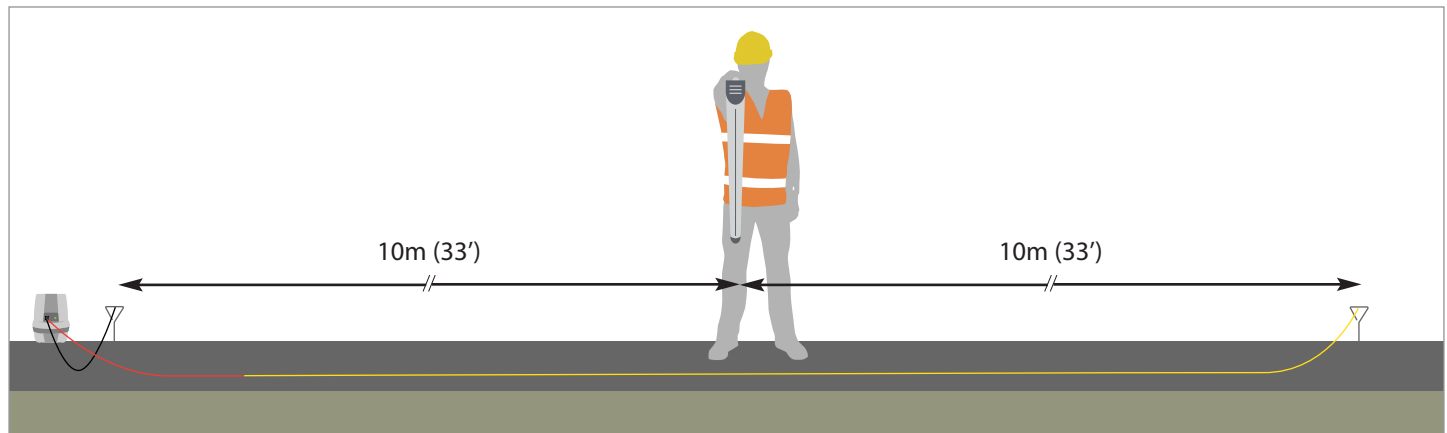

NOTE These Function Checks are approximate only. If a deterioration in performance is suspected for any reason, the equipment should not be used. It should be returned to C.Scope or a C.Scope Authorised Service Centre for more thorough investigation.

Data Logging: Locators

Data Logging

All CXL4, DXL4 and MXL4 Locators automatically record and store how they are being operated. Over 12 months of data (in normal use) can be stored before being overwritten. This data records exactly **how** the Locator has been used, precisely **when** and for **how long**.

*The CXL4-DBG, DXL4-DBG and MXL4-DBG models have in-built GPS technology which records **where** they are being used.*

All models also record every automatic Daily Self Test undertaken.

It is therefore possible to keep a full audit trail of both the activity of the Locator and its functionality.

This data can be transferred to a PC, for immediate analysis and storage, using a USB A male to mini B cable connected to the on-board data connection socket, situated inside the Battery Compartment.

The CXL4-DBG, DXL4-DBG and MXL4-DBG model Locators also have additional Bluetooth™ technology allowing this data to be wirelessly transferred to a smartphone or tablet and then emailed to a PC for analysis.

More detailed information on Data Logging is available from the C.Scope website (csclocators.com/data-logging/).

Data Analysis using PC Toolkit

The C.Scope PC Toolkit is capable of storing and analysing data from a single Locator or a fleet of Locators. The PC Toolkit tabulates the downloaded data and then creates simple charts and tables that summarise the activity patterns. This can help to quickly identify correct or incorrect usage patterns and any potential training requirements.

The C.Scope PC Toolkit is free-to-download from the C.Scope website. Full operating instructions for the PC Toolkit are also available to download from the website: (csclocators.com/technical-support/#documentation).

C.Scope Relay Android App to transfer stored data using Bluetooth™ technology

(CXL4-DBG, DXL4-DBG and MXL4-DBG model Locators only). The Relay App allows immediate on-site transfer of data from a Locator via a smartphone or tablet to a PC. Data can be transferred live or it can be downloaded after a survey is complete. The App shows the locator data on maps and supports exports to Google Maps or Google Earth which can be viewed on most devices.

The C.Scope Relay Android App is free-to-download from Google Play. Open Play Store on your Android smartphone or tablet and search for C.Scope Relay.

Full operating instructions for the C.Scope Relay Android App are available to download from the C.Scope website (csclocators.com/technical-support/#documentation).

Data Logging: Signal Generators/Transmitters

Data Logging

The SGV4 Signal Generators and MXT4 Transmitters automatically record and store how they are being operated. Over 12 months of data (in normal use) can be stored before being overwritten.

*This data records **how** the Signal Generator/Transmitter has been used, precisely **when** and for **how long**.*

The SGV4 and MXT4 also record every Automatic Daily Self Test and any manual Self Test.

It is therefore possible to keep a full audit trail of both the activity of the Signal Generator/Transmitter and its functionality.

This data can be transferred to a PC, for immediate analysis and storage, using a USB A male to mini B cable connected to the on-board data connection socket, situated on the underside of the Signal Generator/Transmitter.

This socket is easily accessible by removing the Accessory Tray. After data transfer, always replace the protective cover over the connection socket.

More detailed information on Data Logging is available from the C.Scope website (csclocators.com/data-logging/).

Data Analysis using PC Toolkit

The C.Scope PC Toolkit is capable of storing and analysing data from a single Signal Generator/Transmitter or a fleet of Signal Generators/Transmitters. The PC Toolkit tabulates the downloaded data and then creates simple charts and tables that summarise the activity patterns. This can help to quickly identify correct or incorrect usage patterns and any potential training requirements.

The C.Scope PC Toolkit is free-to-download from the C.Scope website. Full operating instructions for the PC Toolkit are also available to download from the website: (csclocators.com/technical-support/#documentation).

GPS and Bluetooth™: Locators

The CXL4-DBG, DXL4-DBG and MXL4-DBG Locators have in-built GPS and Bluetooth™ technology.

In-built GPS

The GPS technology allows the geographical position of the Locator to be recorded. To allow this to happen the Locator will first need to detect and then lock on to a signal from a suitable satellite. This process can sometimes take a little time to complete but will not interfere with the Locator's ability to detect underground pipes and cables.

If the GPS symbol does not appear on the Locator display then the Locator is in the process of acquiring a GPS signal.

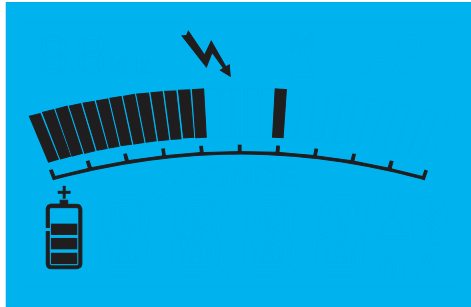

When the Locator has acquired a GPS signal, the GPS symbol will flash on the Locator display.

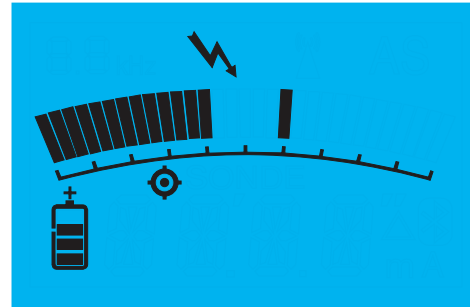

External GPS

Locators with Bluetooth™ can be connected to external GPS units. Consult the external GPS unit manufacturer for further instruction.

Bluetooth™

The Bluetooth™ symbol will appear on the display when the Locator has Bluetooth™ connectivity.

More detailed information on GPS is available from the C.Scope website (csclocators.com/gps/).

i **NOTE** GPS data is logged by the Locator and can be transferred to a PC via USB or to an Android smartphone via Bluetooth™.
NOTE To acquire a GPS signal, place the Locator somewhere with a clear view of the sky and leave it turned on until the Locator display indicates that a GPS signal has been acquired. When the Locator is used for the first time or at a significant distance from the place it last received a GPS signal it could take appreciably longer to identify a location accurately.

General Symbols

Warning - Refer to manual.



Waste electrical products should not be disposed of with household waste. Please recycle where facilities exist. Check with your local authority or retailer for recycling advice.
(In the UK visit www.recycle-more.co.uk)



Conforms to EC safety requirements.



Tested to harmonised standards.
Some restrictions on use in some EC countries.
Contact Local Authorities.



Double Insulated.



CXL4 and DXL4 Locators: Technical Specifications

Controls	On/Off Switch: Spring loaded trigger switch under handle Function Select Switch (FOUR position): P. Power Mode; R. Radio Mode; G. Generator Mode; A. All Scan Mode Sensitivity Control <i>For DXL4 only Depth Button. Push button for live display of depth</i>
Audio Indication	Removable and user replaceable loudspeaker module
Visual Indication	Multi-segment Liquid Crystal Display indicating: Signal Strength; Mode selected; AlarmZone™; Battery Condition; Self Test Indicator <i>For CXL4-DBG and DXL4-DBG only, GPS signal detected, Bluetooth™ activated</i> <i>For DXL4 only in Generator Mode, Depth Measurement</i>
Data Logging	Internal capacity for storing over 12 months of data (in normal use) logged once per second Data logged includes Time/Date, Mode, Sensitivity Level, Received Signal Level, Frequency, Depth, Self Test Result, Swing Indicator <i>For CXL4-DBG and DXL4-DBG only, GPS position</i>
Bluetooth™	Bluetooth 2.1
GPS	GPS/QZSS/GLONASS/SBAS
Data Connector	Standard USB Mini B connector in battery compartment. USB 2.0 Compatible
Self Test	Automatic Daily Self Test
Swing Indicator	Audio beep to indicate incorrect use of the Locator
Generator Mode Frequencies	Simultaneous 131,072Hz and 32,768Hz
Construction	Case moulded from high impact plastic. Designed to withstand 1m (3'3") drop onto a hard surface
Weight (including batteries)	2.65kg (5lb 13oz)
Dimensions	720mm x 280mm x 65mm (28.3" x 11" x 2.5")
Performance	Locate Accuracy: better than 10% of depth Depth Accuracy: ±5% @ 1m (3'3") Line Depth Measurement Range: 0.1m to 9.99m (4" to 32') Line Depth Resolution: 0.01m (0.4") Sonde Depth Measurement Range: 0.1m to 9.99m (4" to 32') depending on Sonde type Sonde Depth Resolution: 0.01m (0.4")
Battery Type	Internal 8 x 'AA' (LR6) cells (either alkaline non-rechargeable or NiMH rechargeable)
Battery Life	40 hours intermittent use at 20°C (68°F) using alkaline cells
IP Rating	65

Notes: Performance figures stated can be affected by site parameters such as ground conditions, temperature, and strong electromagnetic fields.

Specification may be subject to change.

All C.Scope Locators are in compliance with the essential requirements and other relevant provisions of Council Directive 2014/30/EU (EMC).

Compliance has been demonstrated by testing representative samples to the relevant harmonised standards.

All C.Scope Locators comply with the essential requirements and other provisions of Council Directive 2011/65/EU (RoHS).

MXL4 Locator: Technical Specifications

Controls	On/Off Switch: Spring loaded trigger switch under handle Function Select Switch (FOUR position): P. Power Mode; R. Radio Mode; T. Transmitter Mode; A. All Scan Mode Sensitivity Control Depth Measurement Button. Push button for live display of depth Current Measurement Button. Pushbutton for live display of Transmitter current Frequency Select Button. Pushbutton for Transmitter Mode frequency selection
Audio Indication	Removable and user replaceable loudspeaker module
Visual Indication	Multi-segment Liquid Crystal Display indicating: Signal Strength; Mode selected; AlarmZone™; Battery Condition; Self Test Indicator In Transmitter Mode, Frequency selected; Depth Measurement; Signal Current Measurement <i>For MXL4-DBG only, GPS signal detected, Bluetooth™ activated</i>
Data Logging	Internal capacity for storing over 12 months of data (in normal use) logged once per second Data logged includes Time/Date, Mode, Sensitivity Level, Received Signal Level, Frequency, Depth, Signal Current Measurement, Self Test Result, Swing Indicator <i>For MXL4-DBG only, GPS position</i>
Bluetooth™	Bluetooth 2.1
GPS	GPS/QZSS/GLONASS/SBAS
Data Connector	Standard USB Mini B connector in battery compartment. USB 2.0 Compatible
Self Test	Automatic Daily Self Test
Swing Indicator	Audio beep to indicate incorrect use of the Locator
Transmitter Mode Frequencies	Simultaneous 131,072Hz and 32,768Hz; 131,072Hz, 32,768Hz; 8,192Hz; 640 and 512Hz
Construction	Case moulded from high impact plastic. Designed to withstand 1m (3'3") drop onto a hard surface
Weight (including batteries)	2.65kg (5lb 13oz)
Dimensions	720mm x 280mm x 65mm (28.3" x 11" x 2.5")
Performance	Locate Accuracy: better than 10% of depth Depth Accuracy: ±5% @ 1m (3'3") Line Depth Measurement Range: 0.1m to 9.99m (4" to 32') Line Depth Resolution: 0.1m (0.4") Sonde Depth Measurement Range: 0.1m to 9.99m (4" to 32') depending on Sonde type Sonde Depth Resolution: 0.1m (0.4") Current Measurement: 0.01mA to 100mA
Battery Type	Internal 8 x 'AA' (LR6) cells (either alkaline non-rechargeable or NiMH rechargeable)
Battery Life	40 hours intermittent use at 20°C (68°F) using alkaline cells
IP Rating	65

Notes: Performance figures stated can be affected by site parameters such as ground conditions, temperature, and strong electromagnetic fields.

Specification may be subject to change.

All C.Scope Locators are in compliance with the essential requirements and other relevant provisions of Council Directive 2014/30/EU (EMC).

Compliance has been demonstrated by testing representative samples to the relevant harmonised standards.

All C.Scope Locators comply with the essential requirements and other provisions of Council Directive 2011/65/EU (RoHS).

SGA4/SGV4 Signal Generators: Technical Specifications

Controls	All operation is by push button control as follows: On/Off Power Level: For SGA4, 2 available power levels via High and Low Power buttons. For SGV4, 4 available power levels via Increase and Decrease Power buttons Pulse/Continuous Output: toggles between pulse or continuous output using one push button Audio/Mute: toggles between loud or muted audio output using one push button For SGV4, Audio Output: toggles between loud, muted and silent audio output using one push button
Audio Indications	Audio Feedback on button push Audio pitch drops with increasing load current in Connected Mode Audio pitch changes with power level in Induced Mode Audio output pulses to indicate Pulsed Mode Low battery indicated by interrupted Audio and output signal
Visual Indication (for SGV4 only)	Multi-segment Liquid Crystal Display indicating: Output Frequency; Pulse Mode; Continuous Mode; Battery Condition; Output Level (bargraph); Speaker Mute, Self Test Result
Data Connector (for SGV4 only)	Standard USB Mini B connector. USB 2.0 Compatible
Self Test (for SGV4 only)	Automatic Daily Self Test and manual Self Test function
Output	Induced: For SGA4 = 32,768Hz. For SGV4 = 131,072Hz and 32,768Hz Connected = 131,072Hz and 32,768Hz Carrier Pulse Frequency: 7.5Hz (pulsed mode)
Connected Mode	Connection Mode automatically selected when lead is plugged into socket Maximum Output Voltage (open circuit): 28V rms Maximum Output Current (short circuit): 65mA rms Maximum Power: 1W into 400Ω load
Construction	Case moulded from high impact plastic. Designed to withstand 1m (3'3") drop onto a hard surface Incorporates clip on accessory storage compartment
Weight (including batteries, Connection Leads and Earth Stake)	3.4kg (7lb 7 oz)
Dimensions (with Accessory Tray fitted)	360mm x 180mm x 230mm (14.1" x 7" x 9")
Battery Type	Internal 4 x 'D' (LR20) cells (either alkaline non-rechargeable or NIMH rechargeable)
Battery Life	up to 40 hours intermittent use at 20°C (68°F) using alkaline cells
IP Rating	65

Notes: Performance figures stated can be affected by site parameters such as ground conditions, temperature, and strong electromagnetic fields.

Specification may be subject to change.

All C.Scope Signal Generators are in compliance with the essential requirements and other relevant provisions of Council Directive 2014/53/EU (EMC).

Compliance has been demonstrated by testing representative samples to the harmonised standards EN300-330 and EN301-489.

The essential radio test suites have been carried out and the equipment is in conformity with all applicable directives.

All C.Scope Signal Generators comply with the essential requirements and other provisions of Council Directive 2011/65/EU (RoHS).

MXT4 Transmitter: Technical Specifications

Controls	All operation is by push button control as follows: On/Off Power Level: Cycles through four available power levels Frequency: cycles through six available output frequencies Pulse/Continuous Output: toggles between pulse or continuous output using one push button Audio Output: toggles between loud, muted and silent audio output using one push button
Audio Indications	Audio Feedback on button push Audio pitch drops with increasing load current in Connected Mode Audio pitch changes with power level in Induced Mode Audio output pulses to indicate Pulsed Mode Low battery indicated by interrupted Audio and output signal
Visual Indication	Multi-segment Liquid Crystal Display indicating: Output Frequency; Pulse Mode; Continuous Mode; Battery Condition; Output Level (bargraph); Speaker Mute, Self Test Result
Data Connector	Standard USB Mini B connector. USB 2.0 Compatible
Self Test	Automatic Daily Self Test and manual Self Test function
Output	Induced = 131,072Hz and 32,768Hz; 131,072Hz, 32,768Hz and 8,192Hz Connected = 131,072Hz and 32,768Hz; 131,072Hz, 32,768Hz; 8,192Hz; 640 and 512Hz Carrier Pulse Frequency: 7.5Hz (pulsed mode)
Connected Mode	Connection Mode automatically selected when lead is plugged into socket Maximum Output Voltage (open circuit): 30V rms Maximum Output Current (short circuit): 65mA rms Maximum Power: 1W into 400Ω load
Construction	Case moulded from high impact plastic. Designed to withstand 1m (3'3") drop onto a hard surface Incorporates clip on accessory storage compartment
Weight (including batteries, Connection Leads and Earth Stake)	3.4kg (7lb 7oz)
Dimensions (with Accessory Tray fitted)	360mm x 180mm x 230mm (14.1" x 7" x 9")
Battery Type	Internal 4 x 'D' (LR20) cells (either alkaline non-rechargeable or NIMH rechargeable)
Battery Life	up to 40 hours intermittent use at 20°C (68°F) using alkaline cells
IP Rating	65

Notes: Performance figures stated can be affected by site parameters such as ground conditions, temperature, and strong electromagnetic fields.

Specification may be subject to change.

All C.Scope Transmitters are in compliance with the essential requirements and other relevant provisions of Council Directive 2014/53/EU (EMC).

Compliance has been demonstrated by testing representative samples to the harmonised standards EN300-330 and EN301-489.

The essential radio test suites have been carried out and the equipment is in conformity with all applicable directives.

All C.Scope Transmitters comply with the essential requirements and other provisions of Council Directive 2011/65/EU (RoHS).

Maintenance

Handling

C.Scope Locators and Signal Generators/Transmitters are rugged instruments designed for the rigours of every day use. However, to ensure that the specified accuracy is maintained, it is essential to treat the instruments with care by avoiding shocks, vibration and excesses of temperature.

The construction of C.Scope Locators and Signal Generators/Transmitters incorporate weather proof seals, however, they are not guaranteed to prevent water ingress if the equipment is immersed.

Cleaning

The equipment can be cleaned with a sponge dampened with warm water. A mild soap may be used if required. The use of solvents should be avoided.

Do not allow moisture in the battery compartments or near the connectors.

Storage

The equipment should be stored in a clean and dry environment. The temperature should not exceed the range -10°C to +50°C (14°F to 122°F). If stored for long periods the batteries should be removed.

Support Services: Training/ Servicing/ Repairs

Training

This Instruction Manual is comprehensive but cannot fully replace expert tuition. Excellent training is available directly from C.Scope and via authorised C.Scope agents, cost effectively, at your chosen location. C.Scope recommend operators are trained before using the equipment.

Warranty

Details of the C.Scope Warranty Terms and Conditions and how to register the warranty for your C.Scope product are available from the C.Scope website (csclocators.com/warranty/).

Calibration

The C.Scope CXL4, DXL4 and MXL4 and SGA4, SGV4 and MXT4 do not require periodic calibration. Where independent validation and certification is a requirement, this is available from C.Scope and C.Scope Authorised Service Centres.

Servicing

Routine servicing is available from C.Scope and C.Scope Authorised Service Centres.

Repairs

If you suspect equipment is faulty, please check it carefully with a fresh set of batteries. Check the battery connections and rotate the batteries in the holder. Refer to the section in this manual on Function Checks and if possible compare performance with equipment known to be in good working order.

If the problem persists then contact the company from whom you purchased the equipment, or contact C.Scope indicating the nature of the fault. Advice on the best course of action can then be given.



C.Scope International Ltd

Kingsnorth Technology Park
Wotton Road
Ashford
Kent TN23 6LN
United Kingdom

Telephone. +44(0)1233 629181

Fax. +44(0)1233 645897

email. info@cscope.co.uk

website. www.cscopelocators.com

C.SCOPE CXL4, CXL4-D, CXL4-DBG, DXL4-D, DXL4-DBG, SGA4, SGV4, MXL4-D, MXL4-DBG and MXT4
Instruction Manual - Part no. B1094E Issue 1

Copyright © 2017 C.Scope International Ltd. All Rights Reserved.

C.Scope International Ltd make every effort to ensure that the information we provide about our products and their use is correct. We do not accept responsibility for injury, damage, or consequential loss arising from the use of our products. Local, national and international requirements and regulations must take preference.