

LL1505C



spectraprecision.com

**User Guide
Bedienungsanleitung
Manuel de l'utilisateur
Gúia del usuario
Guida per l'uso
Gebruikershandleiding
Käyttäjän opas
Operatörshandbok**



LL1505C

Exit of Laser Beam
 Austritt Laserstrahl
 Sortie du faisceau laser
 Salida del rayo láser
 Uscita del raggio laser
 Uitgang van laserstraal
 Lasersäteen poistuminen
 Utgång från laserstrålen

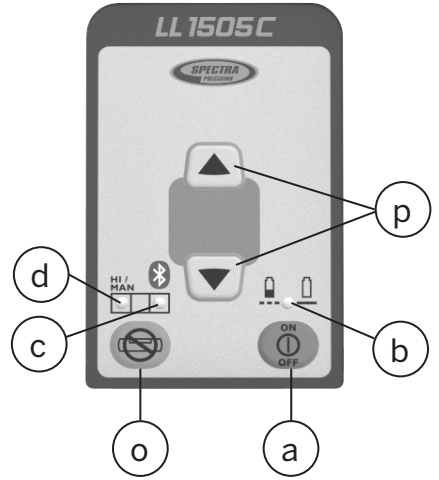
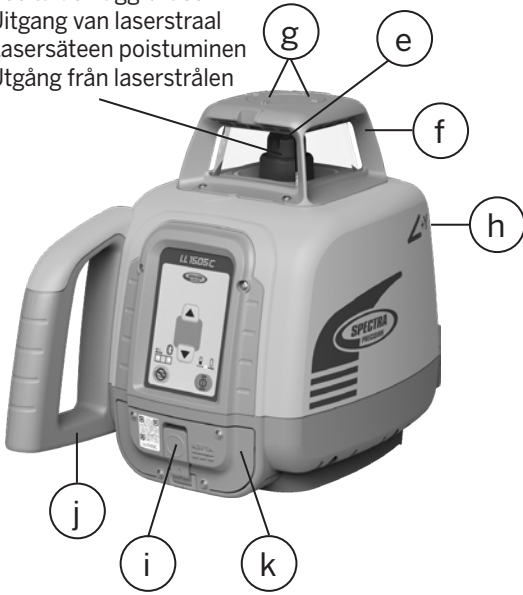

Exit of Laser Beam
 Austritt Laserstrahl
 Sortie du faisceau laser
 Salida del rayo láser
 Uscita del raggio laser
 Uitgang van laserstraal
 Lasersäteen poistuminen
 Utgång från laserstrålen

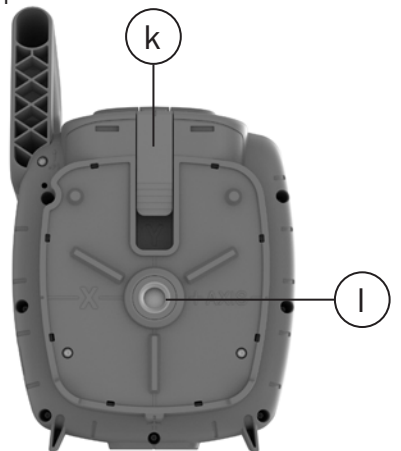
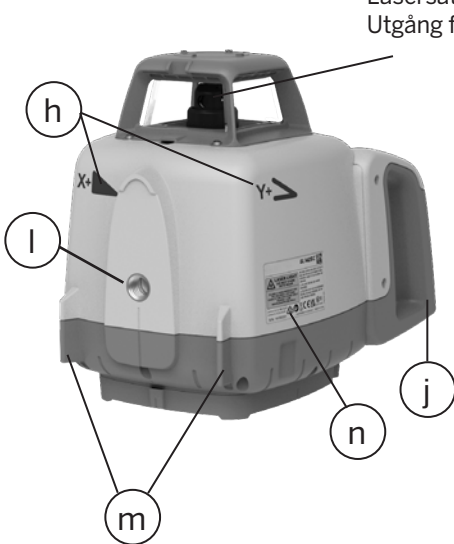

Spectra Precision LL1505C Horizontal Laser

User Guide

Contents

1	Introduction	7
2	Safety Instructions	7
3	Product	9
3.1	General Description	9
3.2	Intended Usage	9
3.3	Product Components	10
3.4	RC1402 Remote Control	11
3.5	Batteries	11
3.5.1	Installing Batteries	11
3.5.2	Battery Status Indication	12
3.5.3	Recharging the Batteries	12
3.5.4	LED Indication on the Charger	12
4	Laser Setup	13
5	Turn On/Off the Laser	13
6	Menu Navigation via RC1402 Only	14
7	Bluetooth® Connectivity	15
8	Horizontal Automatic, Self-leveling Mode	15
9	Manual Mode Horizontal	16
10	Rotation Speed	17
11	Mask Mode	17
12	Standby Mode	18
13	Single Axis Slope Mode (Y axis)	19
14	PlaneMatch (Y-Axis) = Automatic Single Axis Slope	20
15	Settings	22
15.1	Pairing	22
15.1.1	Bluetooth	22
15.1.2	Radio	23
15.2	Shock Warning (HI-alert)	23
15.3	Backlight (RC1402 only)	24
15.4	Sensitivity	24
15.5	Language	25
15.6	Radio Channel	26

16	Info (only via RC1402)	26
17	Determining the Height of Instrument (HI)	30
18	Vertical Application	31
19	Use Receiver	31
19.1	Pair the laser with HL760 receiver	31
19.2	Pair the laser with CR700	32
20	Remote Control RC1402	33
20.1	Powering the RC1402	33
20.2	Turning On/Off the radio remote control RC1402	33
20.3	Pairing the remote control RC1402 with the laser	34
20.4	RC1402 Menu Navigation	34
21	Troubleshooting	35
22	Check Accuracy	37
22.1	Checking accuracy of the Y- and X Axis	37
22.2	Checking accuracy of the Z Axis (vertical)	37
23	Service	38
27.1	Technician Menu	38
24	Protect the Unit	38
25	Cleaning and Maintenance	38
26	Protecting the Environment	38
27	Warranty	39
28	Technical Specification	40
28.1	Technical Specification LL1505C Laser	40
28.2	Technical Specification RC1402 Remote Control	41
29	Declaration of Conformity	41
30	UKCA	41
31	Electro-Magnetic Compatibility	42

1 Introduction

Thank you for choosing one of the Spectra Precision Lasers from the family of precision lasers. This user guide is about the LL1505C self-leveling laser, which is an easy-to-use tool that offers accurate horizontal reference up to 2000 ft. (600m) diameter when using a receiver.

2 Safety Instructions



For hazardless and safe operation, read all the user guide instructions.



Example of the Serial Number Label

- Use of this product by people other than those trained on this product may result in exposure to hazardous laser light.
- The users of this product ensure they have read and understand the user guide.
- Use of this product by people other than those trained on this product may result in exposure to hazardous laser light.
- Always operate the unit in a way that prevents the beam from getting into people's eyes. Watch for reflections from surfaces like windows or flat metal surfaces.
- Do not remove warning labels from the unit.
- Do not use the product in an aggressive or explosive environment.
- If initial service is required, which results in the removal of the outer protective cover, removal must only be performed by factory-trained personnel.
- Using the laser or the accessories different than described in the LL1505C user guide may result in unsafe operation.
- Charge only with specified chargers according to device manufacturer's instructions.
- Charge the batteries only within the specific temperature range; see user guide.
- The charger shipped with the LL1505C is for indoor use only.
- Do not open the battery, dispose of in fire or short circuit; it may ignite, explode, leak or get hot causing personal injury.
- Do not open the rechargeable batteries cage.
- Rechargeable batteries or alkaline batteries shipped with the product may contain small amounts of harmful substances.
-  The products and batteries must not be disposed of with household waste. Dispose in accordance with all applicable federal, state, and local regulations.

- Keep the batteries away from children. If swallowed, do not induce vomiting. Seek medical attention immediately.
- Be sure to charge the battery before using it for the first time and after not using it for an extended length of time.
- There is a risk of electrocution when using leveling rods and poles near electrical installations such as power cables.
- Ensure the product is not damaged so that any unsafe usage can happen.
- Before starting your work, always check the accuracy of the product.
- Spectra Precision is not responsible for any inaccuracy that is caused by not reading the user guide and by any misuse of the product.
- The user of the product is responsible for checking the result for the measurement.
- Any local or national laws and regulations for the use of machines or products described in this document must be followed.
- Never put the laser or the accessories wet in the carrying case for storage.
- Reflections from some surfaces like windows or flat metal surfaces can lead to wrong receiver readings.
- After storage or transportation, the product acclimate to the ambient temperature before use of high accurate measurements.
- Remove the plug from the power outlet for disconnecting the laser from the power source.
- The used power outlet has to be close to the laser and requires easy and free access.

Warning: The LL1505C is a class 2 laser (IEC 60825-1:2014). See laser warning label:



Pic 1 Laser Safety Label Class 2

- Never look into the laser beam or direct it to the eyes of other people. This also applies at greater distances from the laser.

3 Product

3.1 General description

The laser may have been shipped to you with rechargeable NiMH battery pack or with alkaline batteries. In any case alkaline batteries can be used as a backup to power the laser at the job site. When alkaline batteries are used, the plus and minus symbols at the battery door indicate how to put the alkaline batteries into the battery compartment.

The rechargeable NiMH battery pack avoids mis-insertion by design. The rechargeable battery pack can be charged inside or outside the unit.

Note: Charging the rechargeable NiMH battery pack beyond the temperature mentioned in the technical specification chapter 28.1 may lead to decreased battery lifetime or undercharged batteries.

3.2 Intended Usage

The laser described in this user guide transmits a laser beam that can be used for measurement, for alignment, or to reference the correct height of any job site requirement. The laser beam can be used horizontally or sloped. The laser can be detected by a laser receiver that might be part of the configuration. The configuration may also contain a remote control that is used to change settings of the laser. The laser is shipped with a charger that is designed to charge the rechargeable batteries of the laser.

The laser can be used for indoor and outdoor conditions.

3.3 Product Components

LL1505C Laser (Refer to pages 2 and 3)

a	Power Button	Press for one second to turn on the Laser; press and hold for 2 seconds to turn off the laser
b	Battery LED	Shows the amount of battery charge
c	Leveling/Bluetooth® LED	Indicates the automatic level status of the Laser as well as Bluetooth® connection; in standard mode the LED color is green; in Bluetooth® advertising or connection mode the color is blue
d	Manual/Hi-Warning LED	Indicates the manual level status or a laser HI alarm
e	Rotor Head	
f	Sunshade	
g	Sighting Guides	
h	Slope Indication Marks	
i	Recharge Jack	
j	Handle	
k	Battery Door	
l	Tripod Mounts 5/8x11	
m	Stands	
n	Serial Number Label	
o	Manual Button	Quickly press and release activates/deactivates the manual mode/single axis slope mode
p	Up/Down Arrow Button	
u	Rechargeable Battery Pack	B10
v	Universal Charger	CH10

3.4 RC1402 Remote Control (Refer to pages 2 and 3)

The remote control offers the same features and functions when used with LL1505C laser that can be used with the laser itself and it provides even more options to control the laser and to change settings.

a	Power Button	Press for one second to turn on the RC1402; press and hold for two seconds to turn off the RC1402
b	Battery LED	Shows the amount of battery charge
o	Manual Button	Quickly press and release activates/deactivates the manual mode/single axis slope mode
p	Up/Down Arrow Button	
q	Left/Right Arrow Button	
r	Menu Button	Quickly press and release enters the Menu and can be used to return to previous menu position
s	Enter Button	Quickly press and release starts the selected mode
t	LCD	

3.5 Batteries

3.5.1 Installing batteries

Open the battery door. Insert alkaline batteries or the rechargeable battery pack into the housing according to the symbols on the housing or what the design of the battery pack allows you to do.

Note: DO NOT REMOVE RECHARGEABLE BATTERIES FROM THEIR CAGE AND INSTALL ALKALINE BATTERIES IN THE CAGE. SEVERE DAMAGE TO THE UNIT WILL RESULT IF CHARGING IS ATTEMPTED.

Close the battery door.

The LL1505C can be used with a rechargeable NiMH battery pack, which is keyed to prevent mis-insertion. The way it is designed allows only the correct installation.

Alkaline batteries can be used as a backup.

Plus and minus symbols in the battery compartment indicate how to put alkaline batteries into the battery compartment.



Pic 2 Battery Compartment

3.5.2 Battery status indication

WHY: The customer needs to know the battery status when starting the work at the job site.

WHAT: The battery indication shows the remaining battery capacity for the rechargeable battery pack. The battery indication is also shown for alkaline batteries, but the true remaining battery lifetime depends on the battery brand. It also depends on the temperature and the job site conditions (wind, vibrations, etc.), the age of the batteries and how many recharge cycles the batteries have gone through.

HOW: When the battery LED (b) on the laser is off, the battery capacity is good. The battery LED shows the battery capacity by blinking once every second to show that the batteries are weak, and the remaining laser operating time is limited. The end user may consider charging the batteries. A solid battery LED indicates the batteries are empty and this means a remaining battery lifetime of app. 5 minutes. These times depend a lot on ambient temperatures, vibrations caused by machines or wind and the age of the used batteries.

On the RC1402 press the E button (s). The battery symbol will appear and is shown on the screen for app. 5 seconds. The symbol represents relative battery capacity: Empty, almost empty, good, and full (see pic 3).

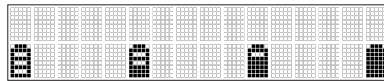

Pic 3 Battery symbols

3.5.3 Recharging the batteries

The battery LED (b) shows the approximate charge of the batteries. The LED will flash when battery voltage is low. When the battery LED blinks the remaining battery lifetime is approximately five minutes. The charger typically requires less than ten hours to charge empty rechargeable batteries fully. For charging, connect the plug of the charger to the recharge jack of the battery pack inside or outside of the laser.

New or long-time out-of-use rechargeable batteries reach their best performance after being charged and recharged five times. For indoor applications the charger can be used as a power supply for the laser.

The batteries can be charged within the laser or externally.

3.5.4 LED indication on the charger

Green LED flashes: Charging in progress.

Green LED permanent on: Charging has stopped.

Red LED permanent on: Error (batteries too cold, too warm, battery failure, etc.)

Note: The batteries should only be charged when the temperature is between 41°F and 104°F (5°C to 40°C). Charging at another temperature than specified may not start the charging process. Waiting for a temperature change may finally start the charging process when the temperature was too low.

Note: The charger has a security timer. The maximum charging time is twelve hours. After twelve hours the charger will always stop the charging process, independently from the charging status of the batteries.

Note: The batteries can be charged during laser usage.

4 Laser Setup

Position the laser horizontally on a stable platform or tripod at the desired elevation. The laser recognizes automatically whether it is used horizontally or vertically when switched on.

It is required to position the laser within its self-leveling range; see chapter 28.1. When the laser is not positioned within the self-leveling range, the manual and leveling indicator LEDs (c and d) flash simultaneously and a warning sound is emitted. Take the appropriate action to set up the laser within the self-leveling range.

5 Turn On/Off the Laser

Turn on the laser pressing the power button (a) for one second. The LEDs (b, c and d) illuminate for one second.

The laser starts self-leveling at once. During the self-leveling process, the laser will not rotate and the laser beam as well as the leveling LED (c) will flash once every second. When the laser is switched on, it always starts in automatic, self-leveling mode. As soon as it is leveled, the rotor will start to spin, and the laser beam is continuously on.

The leveling LED (c) will illuminate solid as long as the laser is in automatic mode but the Height-of-Instrument (HI) alert is not active. When the HI-alert is active the leveling LED flashes every four seconds and 'HI' appears in the display of remote control. The laser constantly monitors the level condition as long as the HI-alert is active.

Pressing and holding the E button (s) on the RC1402 remote control shows the actual rotation speed and the internal product temperature on the display of the remote control RC1402 (see pic 4). This temperature can be different from the ambient temperature.

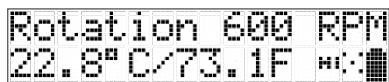

Pic 4 E button info

Info: How to change the settings for HI-alert and to understand what the HI-alert is good for, see chapter 15.1.

To turn Off the laser, press and hold the power button (a) for two seconds.

Note: If the laser is out of its self-leveling range and remains out of it for more than 10 minutes, the unit shuts down completely.

6 Menu Navigation via RC1402 Only

WHY: All features of the LL1505C can be accessed by a menu driven interface using the remote control RC1402. This is an intuitive way to operate the laser that is also easy to remember since it does not require certain two or three finger button presses.

WHAT: The remote control RC1402 has a keypad with some buttons that allows access to the menu. The menu offers only the features that can be selected depending on the set up either horizontally or vertically.

HOW: Press M button (r) to enter the menu and to see a function in the menu or to see a sub menu. Press E button (s) to start the function or to enter the submenu. Scroll within the menu or submenu with the UP/DOWN arrow buttons (p) and select the function by moving the arrow brackets >> <<. An up or down arrow at the right side indicates there are more features scrolling up or down. Press M button (r) to go back to the next level until the standard display is shown again.

Menu functions when the LL1505C is set up in horizontal mode:

```
>>Rotation<<
>>PlaneMatch<<
>>Single Slope<<
>>Mask Mode<<
>>Settings<<
>>Info<<
>>Service<<
```

Menu functions when LL1505C set up in vertical mode:

```
>>Rotation<<
>>Mask Mode<<
>>Settings<<
>>Info<<
>>Service<<
```

7 Bluetooth® Connectivity

WHY: Bluetooth® is an easy way to connect your laser with another device that also provides Bluetooth®. The LL1505C provides Bluetooth® connectivity to connect your smartphone with the laser when using the Laser Remote App from Spectra Precision.

WHAT: The LL1505C provides Bluetooth® connectivity to connect the laser directly with your smartphone using the Spectra Precision® Laser Remote App. The Laser Remote App is available on Google Play Store and on the Apple app store. Download the app from the store to your smartphone and install it.

HOW:

Option 1: When powering the LL1505C, it is in connectivity mode for the first thirty seconds. During this time start the Laser Remote App. When starting the Laser Remote App for the very first time after installation, accept the EULA. If the EULA is not accepted, the App can't be used. It is also required to enable the GPS function on the smartphone. When the Bluetooth® connection was successful, the Laser status LED (c) will continue with blue color and the Laser Remote App shows the standard display of the LL1505C.

Option 2 (requires RC1402 remote control): Press M button (r) on the remote control to enter the menu. Scroll to >>Settings<< and press E button (s) to enter the sub menu. Scroll to >>Pairing<< and press E button (s) to enter the sub menu. Scroll to >>Bluetooth<< and press E button (s) to start the connectivity mode for Bluetooth. The laser is in Bluetooth connectivity mode for 30 seconds.

Now start the Laser Remote App. When the Bluetooth® connection was successful, the Laser status LED (c) will turn blue, and the Laser Remote App shows the standard display of the LL1505C.

>>Settings<< → >>Pairing<< → >>Bluetooth<<

Note: In manual mode the laser status LED (c) will continue with a short blinking in blue color every two seconds indicating the Bluetooth® connectivity.

8 Horizontal Automatic, Self-Leveling Mode

WHY: The laser LL1505C provides a horizontal laser reference for the purpose of measurements on a job site or wherever this is needed. This laser reference can be used to measure any height above or below to achieve the correct elevation.

WHAT: By a rotating laser head, the laser provides a horizontal laser plane, which can be detected with a receiver.

HOW: For this usage, the laser should be placed in a stable way. It is preferred to mount the laser on a tripod. The illumination of the green leveling LED (c) solid or flashing every four seconds confirms the automatic self-leveling mode. Powering on the laser always starts in automatic mode.

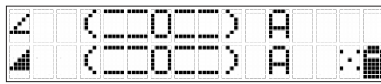

Pic 5 Horizontal automatic mode

The display shown in picture 5 is available via the remote control RC1402 only.

9 Manual Mode Horizontal

WHY: For some applications the user may require a non-level laser plane. This can be used to align non-level elevations or reference hubs. The laser can be sloped in both axes when in horizontal manual mode.

WHAT: When in manual mode the laser is not self-leveled. The laser does not use any sensors for the horizontal leveling or for the slope and there is no control for the slope accuracy and no warning for the Height of the Instrument (HI-alert).

HOW: In horizontal mode pressing the manual button (o) on the laser, on the remote control or on the laser remote app once changes the laser from automatic self-leveling mode to manual mode. Manual mode is indicated by the flashing (once every second) red LED (d).

In manual mode (horizontal), the Y-axis can be sloped by pressing the Up and Down arrow buttons on the remote control, on the laser (p) or on the laser remote app. Additionally, the X-axis can be sloped by pressing the Left and Right arrow buttons (q) on the remote control or on the laser remote app.

Manual mode is indicated in the remote-control display by horizontal lines next to the axis symbols and the letter M, (see pic 6) as well as the blinking manual LED (d).

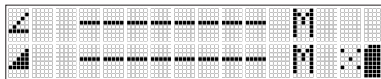

Pic 6 Manual mode horizontal

Note: The display shown in picture 6 is available via the remote control RC1402 only.

A manual inclination of the product using a tilting base, a tripod or similar accessory can be achieved.

To resume automatic self-leveling mode, press the manual button twice again, so the green leveling LED (c) is on again and the laser self-levels. On the remote control the automatic mode display is shown (see pic 5).

Note: In horizontal manual mode, both the X and Y axis are in manual mode and there is no sensor that watches the axis. Even when the product is designed to avoid unforeseen drift as much as possible, there is the risk of a drift that the user must not overlook. It is mandatory that the user watches the laser plane in manual mode for any unforeseen behavior since there is no warning for the height of instrument or any changes caused by wind, vibrations, or temperature changes.

Note: Pressing the arrow buttons will start the sloping slowly and the sloping speed will increase over time. A short arrow button release and press will restart the sloping with the same speed since a long arrow button release will start the sloping slowly again.

Note: For manual mode in vertical see chapter 18.

10 Rotation Speed

WHY: Different applications or use cases may require different rotation speeds.

WHAT: The LL1505C provides three rotation speeds. 300, 600, and 900 RPM.

HOW: This feature requires the laser remote RC1402, or the laser remote app. Press 'M' button on the RC1402 to enter the menu. Using the Up or Down buttons (p), scroll to and select >>Rotation<<. When selected, press 'E' button to enter the rotation menu. Using the Up or Down buttons (p), choose the rotation speed 300, 600 or 900 RPM. When selected, press 'E' button to confirm and start the rotation speed. The factory setting is 900 RPM.

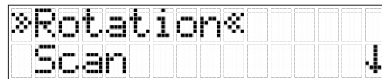

Pic 7 Rotation menu



Pic 8 600 RPM choice

NOTE: When powering the laser, the laser starts with the last used rotation speed.

11 Mask Mode

WHY: In some applications or on some job sites, the laser beam is not acceptable in all directions. Maybe the laser should not disturb the workers in a certain direction, or the laser may hit some reflective surfaces like windows or glossy metal surfaces. These surfaces can create laser reflections that will be detected by the laser receiver and will lead to wrong measurements and laser readings.

WHAT: The mask mode allows you to electronically shut off the laser in some sections so the laser would not create the conflicts described in the paragraph above. The LL1505C can shut off the laser beam in one, two or three sections. These sections are limited to the size of the lighthouse windows in the four axes. The status of the mask mode is shown on the standard display LCD of the remote control; see pic 12.

Option 1: To activate the mask mode on the + or – Y axis, press the Up or Down arrow button (p) on the laser or on the remote control RC1402 and the manual button (o) within one second. To activate the mask mode on the + or – X axis, press the Left or Right arrow button (q) on the laser or on the remote control RC1402 and the manual button (o) within one second.

Option 2: Press and release the M button (r) at the keypad of the remote control to enter the menu. Select >>Mask Mode<<. (pic 9). Depending on the sector the beam should be shut off, the desired sector can be selected. For selecting the sector, press and release one of the arrow buttons. When all sectors have been set, press E button (s) to store the mask sector selection until the unit is turned off. Up arrow button will select the +Y axis, the Down arrow will select the -Y axis. The Right arrow button will select the +X axis and the Left arrow button will select the -X axis.

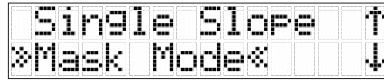

Pic 9 Mask mode menu

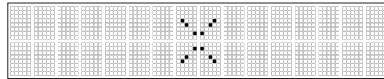

Pic 10 Display no mask mode

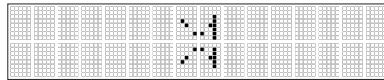

Pic 11 Mask mode +X axis

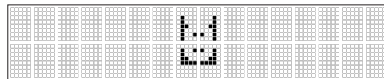

Pic 12 Mask mode +X, -Y, -X axis

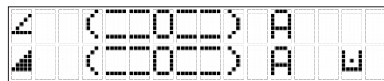

Pic 13 Mask mode on standard display

Note: Maximum three sectors can be shut off.

Note: The laser always powers up with the mask mode deactivated.

12 Standby Mode

WHY: During the work on a job site there might be some time where the laser is not used (e.g. lunch break). Maybe there is the request or the need to save batteries. For this approach it is not recommended to switch off the laser since the new laser set up will be time-consuming and should be avoided.

WHAT: It is recommended to bring the laser into standby mode to save batteries. The self-leveling will be stopped and the beam will be turned off while the HI alert is still active. The display of the remote control shows – Standby – (see pic 14) and the HI/ MAN-LED (d) flashes red every five seconds. The standby mode ends automatically if the device orientation changes from horizontal to vertical or vice versa. When the laser is in Standby mode for more than 8 hours, or when the batteries are empty, there is an automatic switch off.

HOW: Press and hold the manual button (o) at the laser or RC1402 remote control for three seconds to bring the laser into the standby mode. Press and hold the manual button (o) again for three seconds to deactivate the standby mode and to restore full operation of the laser.

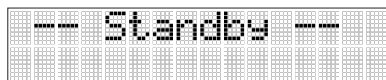

Pic 14 Standby Display

13 Single Axis Slope Mode (Y axis)

WHY: On some jobsites the fall or the rise of the ground between two existing elevations is not known. It is the goal to match the fall/rise of the ground or between the two existing elevations. Some examples of this are short ramps, driveways, etc.

WHAT: Single axis slope mode is available for the Y axis in the horizontal product set-up. Single axis slope mode is a way to slope the Y axis that will be in manual mode finally while the X axis continues in automatic self-leveling mode.

HOW:

Option 1: At the laser or the RC1402 remote control, when the automatic leveling status LED (c) is blinking, press the manual button (o) twice to activate the Y axis single slope mode. The Y axis single slope mode is indicated by the simultaneously flashing red and green LEDs once every second.

When the Y axis is in Single Axis Slope Mode, use the up and down arrow buttons (p) to slope the Y axis while the X axis remains in self-leveling mode.

Option 2: At the remote-control press M button (r) to enter the menu. Scroll down to >>Single Slope<< and press the E button (s) to enter the sub menu. Choose >>MAN Y<< and press E button to bring the Y axis into the Single Axis Slope Mode. The Y axis single slope mode is indicated by the simultaneously flashing red and green LEDs once every second.

When the Y axis is in Single Axis Slope Mode use the up and down arrow buttons (p) to slope the Y axis while the X axis remains in self-leveling mode.

Note: The axis that is in Single Axis Slope Mode, is in manual mode and there is no sensor that watches any drift for this axis. The user must ensure to watch any change in the laser set-up.

14 PlaneMatch (Y-Axis) = Automatic Single Axis Slope

The PlaneMatch function requires a remote control RC1402 or the laser remote app.

WHY: On some jobsites the fall or the rise of the ground or between two existing elevations is not known. It is the goal to match the fall/raise of the ground or between the two existing elevations. This will eliminate the need for complex calculations and will avoid errors. PlaneMatch is an easy way to connect two reference points with a constant laser beam that can be used as a reference.

WHAT: Using the HL760 or CR700, the automatic PlaneMatch function can match the current fall/rise and will end in a sloped laser plane. The feature will typically work to a maximum distance of 80 m (240 ft.). As the result of the PlaneMatch functionality, the laser will be in Single Axis Slope mode. This means that the Y axis is in manual mode and the X axis is in automatic self-leveling mode.

The PlaneMatch mode can be activated in horizontal automatic mode only.

The PlaneMatch function is available only in the Y-axis.

HOW:

- 1.) Set up the laser over the first reference point (see pic 15).
- 2.) Attach the HL760 / CR700 receiver to a grade rod. Place the rod next to the laser and adjust the height of the receiver next to the laser until the laser receiver is on-grade. Now the on-grade position of the receiver has the same elevation as the laser beam (=height of instrument HI), (see pic 15).
- 3.) Without changing the receiver's elevation on the rod, position the rod at the second reference point facing the front of the receiver towards the laser (see pic 15).
- 4.) Use the sighting guides on the top of the laser to align the laser to the receiver. Turn the laser on the tripod until it is roughly aligned to the receiver's position.
- 5.) Press and release the M button (r) and select >>PlaneMatch<< (see pic 16).
- 6.) Press and release E button (s) to open the PlaneMatch submenu; confirm Y axis by pressing the E button again to start the PlaneMatch function (see pic 17).
- 7.) The laser starts to search for the receiver. The remote control display shows a flashing "PM" and the HL760 / CR700 display shows a flashing "-GM-" (see pic 18 and 19) during the time the laser is searching and adjusting the beam to the on-grade position. When PlaneMatch has been completed, the HL760 / CR700 goes back to the standard elevation display. The remote control will display the final status of the laser that is now in single axis slope mode for the Y axis. The laser shows its status by simultaneously flashing red and green LEDs (once a second). The Y axis is in manual mode and the X axis is in automatic mode.
- 8.) Exiting PlaneMatch can be done by pressing the Manual button (o) twice where the unit always goes back to automatic mode.

Note: When the function PlaneMatch is complete, the laser will be in single axis slope mode for the Y axis. This means, the Y axis is in manual mode and the X axis is in automatic self-leveling mode. There might be no warning for changes in the Y axis when there is a drift of the laser plane. The user must ensure to watch any change in the laser set-up.

Note: The HL760 / CR700 can be removed from their position to take measurements on the job site.

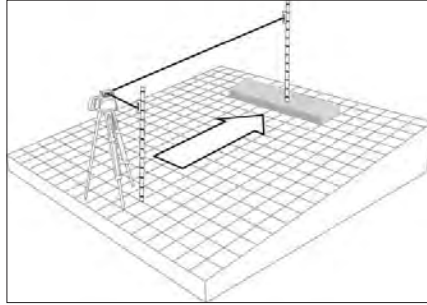

Pic 15 PlaneMatch Setup

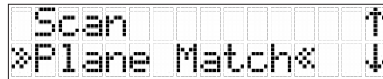

Pic 16 PlaneMatch Menu

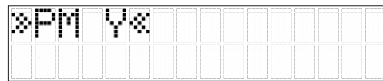

Pic 17 PlaneMatch Submenu

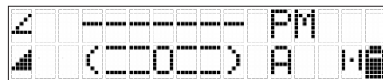

Pic 18 PlaneMatch Laser Display

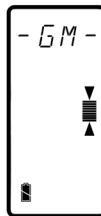

Pic 19 PlaneMatch (GradeMatch) HL760/CR700 display

Note: When started in manual mode, the laser will switch into single axis slope mode.

15 Settings

The settings menu requires the remote control RC1402.

WHY: Different use cases, job sites, users and applications require different settings for the laser.

WHAT: The chapter >>Settings<< describes how the laser can be adjusted according to the requirements of the job application or according to the own preference how to work.

HOW: Press the M button (r) on the remote control to enter the menu. Scroll to >>Settings<<, press the E button (s) to enter the settings menu (see pic 20). With the arrow buttons UP/DOWN scroll to the sub-menus.

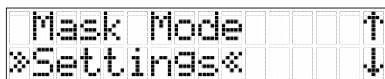

Pic 20 Settings menu

15.1 Pairing

15.1.1 Bluetooth

WHY: Bluetooth® is an easy way to connect your laser with another device that also provides Bluetooth®. The LL1505C provides Bluetooth® connectivity to connect your smartphone with the laser when using the Laser Remote App.

WHAT: The LL1505C provides Bluetooth® connectivity to connect the laser directly with your smartphone using the Spectra Precision® Laser Remote App. The Spectra Precision® Laser Remote App is available on Google Play Store and the Apple app store. Download the app from the store to your smartphone and install it.

HOW:

Option 1: When powering the LL1505C it is in connectivity mode for the first thirty seconds. During this time start the Laser Remote App. When starting the Laser Remote App for the very first time after installation, accept the EULA. If the EULA is not accepted, the App can't be used. It is also required to enable the GPS function on the smartphone. When the Bluetooth® connection was successful, the Laser status LED (c) will continue with blue color and the Laser Remote App shows the standard display of the LL1505C.

Option 2 (only via RC1402): Press M button (r) on the remote control to enter the menu. Scroll to >>Settings<< and press E button (s) to enter the sub menu. Scroll to >>Pairing<< and press E button to enter the sub menu. Scroll to >>Bluetooth<< and press E button to start the connectivity mode for Bluetooth. The laser is in Bluetooth connectivity mode for 30 seconds. Now start the Laser Remote App. When the Bluetooth® connection was successful, the laser status LED (c) will turn blue, and the Laser Remote App shows the standard display of the LL1505C.

>>Settings<< → >>Pairing<< → >>Bluetooth<<

15.1.2 Radio

WHY: Radio communication is needed for the remote control to control the laser and for the receiver to do some of the automatic features. When the laser has been shipped with the remote control and the receiver, both are usually paired with the laser. Nevertheless, for some reason sometimes this radio pairing is lost. When the remote control or receiver has been bought separately from the laser, there is no established pairing.

WHAT: The radio connectivity must be set up to ensure radio communication between the laser and the remote control and/or the receiver.

HOW: Start with the laser being off. Press and hold the Manual button (r) and power the laser with the on/off button (a). The laser is now in radio pairing mode for six seconds.

Within these six seconds bring the remote control (see chapter 20) or the receiver (see chapter 19) into pairing mode as well.

Note: When pairing the receiver, it is recommended to start with the receiver.

15.2 Shock Warning (HI-alert)

WHY: The Shock Warning (HI-alert) function monitors the height of your instrument on the job site. Any changes of the Height of Instrument by bumping a tripod leg or sinking of a tripod leg will cause an alert. This ensures the accuracy of your work. When the tripod change is equal to approximately 3 mm (1/8 in) the laser would give a warning.

During the setup of the laser, the Shock Warning is not activated since this may result in a constant alarm when the height and position of the laser or tripod is changed. This is why the LL1505C provides a delay time for the Shock Warning. The delay time for Shock Warning should allow the user a certain amount of set-up time without any alarm of height changes. The Shock Warning would now be active when the delay time is over and when the set-up has been completed within this time frame.

WHAT: When entering alert mode, the rotation stops, the laser beam turns off, a warning sound is heard, and the HI/MAN LED (d) flashes every 4 seconds and HI symbols appears at the right corner on the main display in the remote control. The user now must check the setup of the laser and eventually must reset the laser to ensure the initial situation is achieved again. To achieve this, the user has created some elevation reference in the very beginning. To allow for the set-up, the LL1505C provides three options for the Shock Warning (HI-Alert) delay time. Under the remote-control menu item HI-Alert the user can switch off the Shock Warning (not recommended) or can change the delay time to activate the Shock Warning. This delay time can be changed to 30 seconds or five minutes (default).

HOW: On the remote control press the M button (r) to enter the menu. Scroll to >>Settings<<, press the E button (s), scroll to >>HI-Alert<< (see pic 21), press E button to open the HI-alert submenu. Choose delay time 5 min (default), (see pic 22), 30 seconds or HI-Off, (see pic 23), by scrolling to the option and confirming by pressing the E button on the remote control or in the laser remote app when used.

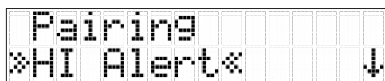

Pic 21 HI Alert menu

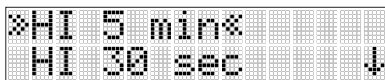

Pic 22 HI Alert 5 min

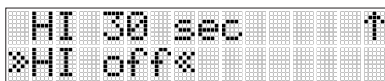

Pic 23 HI Alert off

15.3 Backlight (RC1402 only)

WHY: Under dark ambient light conditions, the display is often hard to read. A backlight helps to read the display from the remote control. Using the backlight too long reduces battery lifetime.

WHAT: The remote display provides a backlight to read the display easily. Depending on the need of good visibility for the backlight or saving the battery life, the laser provides two different times to shut off the backlight. The times are 8 seconds (default) or 60 seconds.

HOW: Press the M button (r) to enter the menu, scroll to >>Settings<<, press E button (s) to enter the sub menu. Scroll to >>Backlight<< and press E button to enter the sub menu. Choose backlight time 8 seconds (default) or 60 seconds. Press E button to confirm the selection.

>>8 seconds<< (default)

>>60 seconds<<

15.4 Sensitivity

This function requires the remote control RC1402.

WHY: The job site conditions might be different as well as the requirements according to accuracy. On some job sites there are a lot of vibrations caused by machines or the weather is stormy and there is a lot of wind.

WHAT: The LL1505C provides different levels of sensitivity depending on the job site conditions. In all levels of sensitivity, the laser will level to the most accurate level value. Nevertheless, the tolerance allowing for a disturbance by vibration or wind will be different. The three different levels of sensitivity provided by the LL1505C are “Low” to work with high wind and vibrations, “Middle” to work under normal job site conditions (default) and “High” to work in very calm conditions.

HOW: Press M button (r) on the remote control to enter the menu, scroll to >>Settings<< and press E button (s) to enter the sub menu. Scroll to >>Sensitivity<<, and press E button again to enter the sub menu. Choose the desired level of sensitivity >>Low<<, >>Middle<< (default), or >>High<<.

>>Low<<
>>Middle<<
>>High<<

15.5 Language (RC1402 only)

WHY: The company using the LL1505C may have employees from different countries. The laser may be shifted from one person to another, each with a different native language. Each person on a job site using the LL1505C wants to use the laser in their known language.

WHAT: The LL1505C provides via the remote control many different languages for the interface. Standard language is English. Using the laser remote app with the laser requires no change of the language for the app. The laser remote app will use the language that is used for the smart phone when this language is supported by the laser. If the smart phone uses a language that is not supported by the laser, the laser remote app uses English as the language.

HOW: Press M button (r) to enter the remote-control menu. Scroll to >>Settings<< and press E button (s) to enter the sub-menu. Using UP/DOWN buttons (p) scroll to >>Language<< (see pic 24). Press E button (s) to enter the sub-menu. Scroll to the language, select the language moving these >> << symbols by scrolling and press E button to confirm.

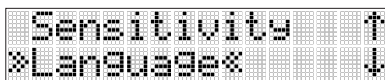

Pic 24 Language Menu

>>English<<	>>Deutsch<<
>>Italiano<<	>>Francais<<
>>Español<<	>>Portugues<<
>>Nederlands<<	>>Dansk<<
>>Norsk<<	>>Svenska<<
>>Suomi<<	>>Polski<<
>>Turkce<<	>>Cestina<<

15.6 Radio Channel

WHY: The laser LL1505C is using radio communication between the laser and the remote control. Using PlaneMatch there is radio communication between the laser and the receiver HL760/CR700. On job sites there can be some radio pollution within some of the radio channels. When radio communication is not working properly, one solution to fix the problem can be to change the radio channel to use a radio channel that is more open.

WHAT: The LL1505C provides six different radio channels. Those are 0 (default), 1, 2, 3, 4 and 5.

HOW: The radio channel can be changed only using the remote control! Press M button (r) on the remote control to enter the menu. Scroll to >>Radio Channel<<, (see pic 25) and press the E button (s) to open the sub menu. The desired radio channel 0 to 5 can be selected by scrolling the >> << symbols using the UP/DOWN (p) buttons. Press the E button to confirm the selected radio channel.

Note: After changing the radio channel on the laser, the remote control RC1402 and the HL760/CR700 must be paired again. During the pairing process, they will adapt to the new radio channel.

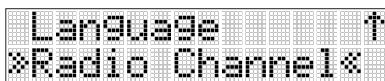

Pic 25 Radio channel menu

>>0<<
>>1<<
>>2<<
>>3<<
>>4<<
>>5<<

16 Info (RC1402 Remote Control Only)

WHY: The info menu provides some information about the laser. This information can be helpful for any communication with your dealer or service technician when a problem occurs with the laser during usage. This can be misbehavior on any features and functions, a problem in radio communication between laser, remote control, or laser receiver.

The run time of the laser can be reviewed here as well. This can be helpful for rental purposes.

WHAT: Information about the laser is laser model number (LL1505C), battery status, temperature within the laser in °C and °F, PWR-Firmware revision, SENS-Firmware revision, RADIO-Firmware revision, and the internal serial number (SN) in HEX-code that is different to the serial number printed on the serial label.

Information about the runtime of the laser is the time the laser has been used since it was produced. The runtime is shown in hours and minutes. It cannot be set to zero.

Information about the current radio channel that has been selected for the communication path is available.

HOW: Press the M button (r) on the remote control to enter the menu; using the UP/DOWN buttons (p) scroll to >>Info<< (see pic 26). Press E button (s) to enter the Info sub-menu. Scroll to >>About LS<< (see pic 27), and press E button to enter the sub-menu. Scroll to >>Runtime<< (see pic 27) and press E button to see the current runtime. Sub-menus in >>About LS<<:

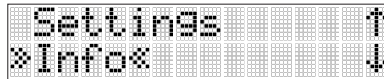

Pic 26 Info menu

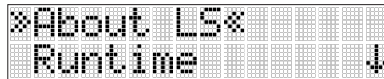

Pic 27 About laser menu

Scroll to >>Model<< (see pic 28) and press E button to read the model number of the laser (see pic 29).

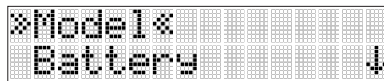

Pic 28 Model number menu

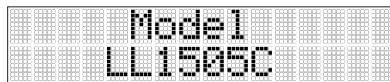

Pic 29 Model number

Scroll to >>Battery<< (see pic 30) and press E button to show the battery status of the laser: Good. Weak. Empty (see pic 31).

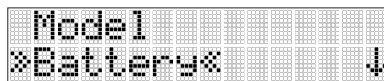

Pic 30 Battery menu



Pic 31 Battery status good

Scroll to >>Temperature>> (see pic 32) and press E button to show the current temperature within the product in °C and °F (see pic 33).

Note: This is the internal product temperature, and this can be different to the ambient temperature.

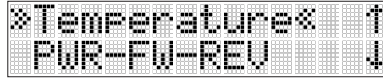

Pic 32 Temperature menu

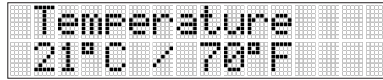

Pic 33 Laser temperature °C / °F

Scroll to >>PWR-Firmware<< (see pic 34) and press E button to read out the revision of the PWR-Firmware (see pic 35).

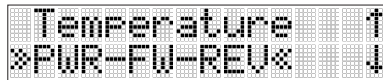

Pic 34 PWR-Firmware menu

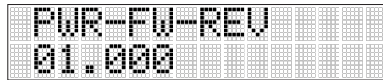

Pic 35 PWR-Firmware revision

Scroll to >>SENS-Firmware<< (see pic 36) and press E button to read out the SENS-Firmware revision.

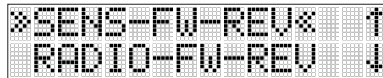

Pic 36 Sens firmware menu

Scroll to >>RADIO-Firmware<< (see pic 37) and press E button to read out the SENS-Firmware revision.

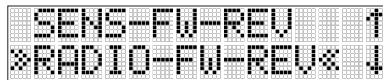

Pic 37 Radio firmware menu

Scroll to >>Serial Number<< (see pic 38) and press E button to read out the internal serial number of the laser in HEX code (see pic 39).

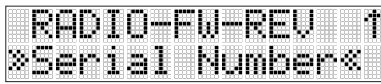

```
RADIO-FW-REV  ↑
*Serial Number*
```

Pic 38 Serial number menu

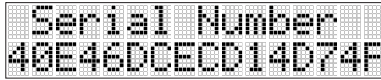

```
Serial Number
40E46DCECD14D74F
```

Pic 39 Laser serial number

In menu >>Runtime<< (see pic 40), press E button to enter the menu and to see the current runtime of the laser (see pic 41).

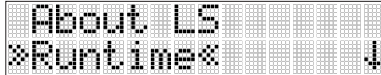

```
About LS
*Runtime* ↓
```

Pic 40 Runtime menu

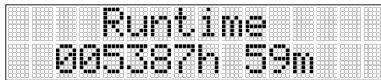

```
Runtime
005387h 59m
```

Pic 41 Laser runtime

Scroll to >>Radio<< (see pic 42) and press E button to show the current radio channel, (see pic43).

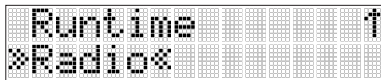

```
Runtime ↑
*Radio*
```

Pic 42 Radio channel menu



```
RF Channel = 0
```

Pic 43 Radio channel

17 Determining the Height of Instrument (HI)

WHY: For most applications it is necessary that the height of instrument (HI) is known because it is used as a reference height and control elevation on a regular basis.

WHAT: The height of instrument (HI) is the elevation of the laser beam in relation to a benchmark or reference point. The HI is determined by adding the grade-rod reading to a benchmark or known elevation.

HOW: Set up the laser and place the grade-rod on a jobsite benchmark (BM) or known elevation. Slide the receiver up or down the grade-rod until it shows an on-grade reading. Add the grade-rod reading to the benchmark to determine the height of instrument

Example:

Benchmark = 30.55m (100.23ft)

Rod reading = +1.32m (4.34ft)

Height of instrument = 31.87m (104.57ft)

Use this HI as a reference for all other elevations.

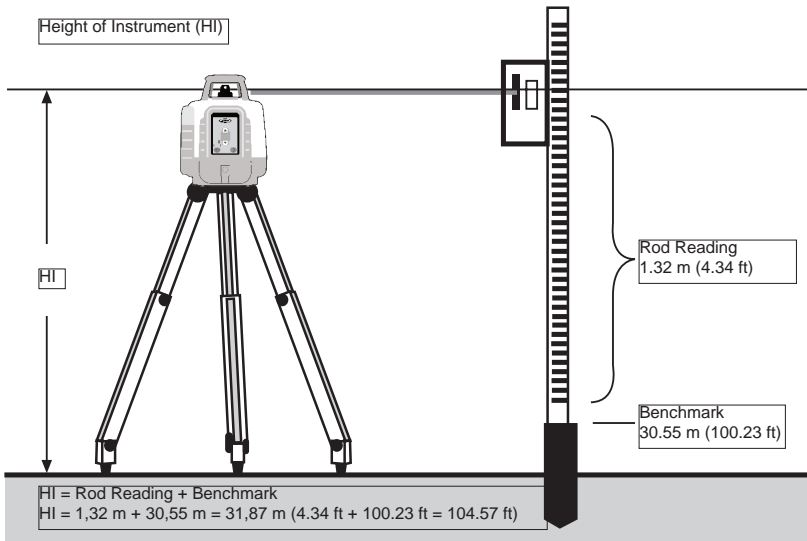

18 Vertical Application

WHY: The LL1505C can be set up in vertical position but the laser is now in manual mode only. This allows the usage of the laser when self-leveling is not required to use the laser as a non-level reference. Maybe the application assures that the reading will be done at the same elevation by purpose.

WHAT: The LL1505C provides a laser plane that is not leveled, neither in the Y axis nor in the X axis.

HOW: Setting up the laser in vertical the LL1505C is in manual mode. There is no further action required. The red blinking manual LED (d) indicates the manual mode.

Now the laser plane can be adjusted using the UP/DOWN arrow buttons (p) for the Y axis or using the LEFT/RIGHT arrow buttons (q) for the X axis.

When changing the laser set up from vertical to horizontal, the laser changes in automatic self-leveling mode.

Note: In vertical manual mode, both the X axis and Y axis are always in manual mode and there is no sensor that watches the axis. Even when the product is designed to avoid unforeseen drift as much as possible, there is the risk of a drift for any reason that the user must overlook on its own responsibility. It is mandatory that the user watches the laser plane in X and Y axis for any unforeseen behavior since there is no warning for the position or any changes caused by wind, vibrations, or temperature changes.

Note: For manual mode in horizontal see chapter 9.

19 Use Receiver

19.1 Pair the laser with HL760 receiver

WHY: To use automatic functions like PlaneMatch, the laser and the HL760 need to be paired so they can communicate with each other.

WHAT: The pairing of the laser and the receiver will establish a radio communication between the laser and the receiver which is only used for this combination.

HOW: Make sure the laser is turned off.

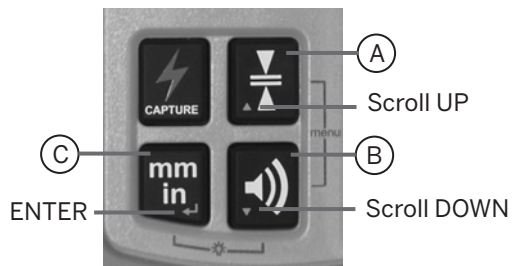

First, turn on the receiver, then press and hold the scroll up (A) and scroll down (B) button for two seconds simultaneously. After two seconds, the display shows MENU first, then RDIO. Press and release the Enter button (C). The display shows the current radio mode. Mode LS means the receiver is ready to pair with a compatible laser; Mode HL means the receiver is ready to pair with another HL760 or CR700; Mode OF means the radio function of the receiver is disabled.

If the display does not show Mode LS, press Units button (C). The current mode flashes, now press dead band button (A) or audio button (B) until LS is flashing.

Press Units button (C) button to enter selection.

Press and release the Audio button (A) to display "PAIR".

Press the Units button (C) again to start the pairing process; the display shows a rotating bar. The HL760 is now in pairing mode.

On the laser, press and hold the Manual button (o) and turn on the laser. The laser starts and a fast-flashing Battery LED (b) indicates that the laser is in pairing mode. After completing PAIR OK will be displayed on the receiver and a long beep occurs.



The LL1505C has been paired with this receiver and turns back to the standard function. On the HL760 press and release the power button twice to exit the menu at the receiver. A laser symbol and an antenna are lit to confirm the receiver is ready for communication with the laser.

Note: The laser with antenna symbol in the display is the indication for the connection status of receiver and laser. When an automatic function with laser and receiver fails, the missing symbol is a first indication of a root cause. When the symbol is missing this can be the reason:

- The laser is off. Check the laser, it may have shut off for some reason. Turn it on and check if the symbols will come back after a few seconds.
- The laser is not paired with the receiver. Maybe this laser was paired with the receiver before but for some reason the pairing has been lost. Start the pairing process described in this chapter.

19.2 Pair the laser with CR700

Make sure the laser is turned off.

First turn on the CR700, press the power (menu) button quickly, scroll to RDIO menu. Make sure RDIO LS is shown. If not, press the enter button: symbol starts to blink. Scroll until LS is blinking. Press the enter button. Make sure LS is no longer blinking. Scroll to PAIR. Press the enter button. CR700 is now in pairing mode.

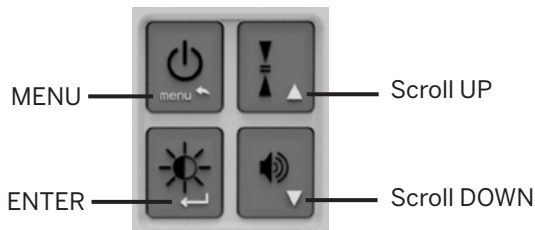

Now continue with the laser. Press and hold the Manual button (o) on the laser and turn on the laser. The laser starts and a fast-flashing Battery LED (b) indicates that the laser is in pairing mode. After completing PAIR, OK will be displayed on the receiver and a long beep occurs.

The LL1505C has been paired with this receiver and turns back to the standard function. On the CR700 press and release the power button once to exit the menu. A laser symbol and an antenna are lit to confirm the receiver is ready for communication with the laser.

Note: The laser with antenna symbol in the display is an indication for the connection status of receiver and laser. When an automatic function with laser and receiver fails, the missing symbol is a first indication of a root cause. When the symbol is missing this can be the reason:

- The laser is off. Check the laser, it may have shut off for some reason. Turn it on and check if the symbols will come back after a few seconds.
- The laser is not paired with the receiver. Maybe this laser was paired with the receiver before but for some reason the pairing has been lost. Start the pairing process described in this chapter.

20 Remote Control RC1402 (Optional)

20.1 Powering the RC1402

- Open the battery door using a coin or similar pry device to release the batter door tab on the RC1402.
- Insert two AA batteries noting the plus (+) and minus (-) diagrams inside the battery housing. Rechargeable batteries can be used optional but need to be charged externally.
- Close the battery door. Push down until it “clicks” into the locked position.



20.2 Turning On/Off The Radio Remote Control RC1402

The radio remote control is a hand-held device that allows you to send operational commands to the laser from a remote location.

Press the power button to turn on the radio remote control.

To turn off the radio remote control, press and hold the power button for two seconds.

When the remote control is initially turned on, the standard display (model number and software version) appears for the first three seconds (see pic 44) then the RC1402 LCD shows the current laser function. This standard display is also shown when the RC1402 is out of operating range or not paired with the laser or the paired laser is not switched on.

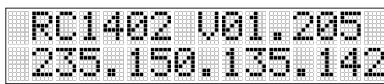

Pic 44 RC1402 standard display

With every button press, the LCD backlight is activated and turns off automatically if no button is pressed for 8 seconds or 60 seconds depending on the settings. How to change the settings for the backlight, see chapter 15.3

Note: Five minutes after the last button press, the remote control turns off automatically to save battery.

20.3 Pairing The Remote Control RC1402 With The Laser

WHY: The communication between remote control RC1402 and the laser LL1505C is based on a radio communication path. This enables a unique communication path that ensures only the paired laser will be controlled by the paired remote control.

WHAT: When the pairing has been lost for some reason, when the radio channel has been changed or when the remote has been replaced, the pairing needs to be reestablished.

HOW: First, make sure the laser and the remote control are turned off. Start with the laser pressing and holding the Manual button when turning on the laser. Now the laser is in pairing mode for the next six seconds. Within this time frame continue with the remote control. Press and hold the manual button on the remote control and turn on the remote control.

The laser beeps and the remote's display show 'Pairing OK' (see pic 45) for one second and then the display shows the current working mode.

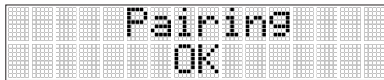

Pic 45 Pairing OK

20.4 RC1402 Menu Navigation

Press and release 'M' button (r) to enter the Menu.

The actual available function will be marked in arrow brackets >> <<. A down or up arrow at the right sites indicates that the user can scroll up/down through the menu using the 'Up/Down' arrow buttons. Press and release button 'E' to open the submenu or start the selected function.

Press and release button 'M' changes the unit always back to the previous or standard display.

Press and release the Up/Down buttons (p) until the desired function at the selected menu row is marked.

Menu functions for the LL1505C:

>>Rotation<<
>>PlaneMatch<<
>>Single Slope<<
>>Mask Mode<<
>>Settings<<
>>Info<<
>>Service<<

21 Troubleshooting

Any error message at the remote control RC1402 or the app can be confirmed with a short press on the button E or on the OK (app). The table below shows the related description and possible solutions. The laser or remote control shows a string of numbers where only the last two or three digits are needed for the error code list below. Using the laser remote app, the text shown below will be provided directly through the app depending on the error code.



Pic 46 Example error code shock warning

The next service center should be contacted if a different error message as shown on the table will be displayed.

Error code	Description	Solution
030	PWR-Board data recovered	Press E button (s) on the remote control or OK button in the app to confirm the error message. The laser has changed to default settings. You may need to redo your personal settings. The laser may have lost the pairing to the remote control, to the HL760/CR700 or the smartphone. Please check. You may need to redo the pairing.
035	SENS-Board data recovered	Press E button (s) on the remote control or OK button in the app to confirm the error message. It is recommended to check the laser accuracy.
120	HI-alert – Unit height has changed	Press E button (s) on the remote control or the OK button in the app to delete the error message. Check Laser Beam Elevation and Laser Setup.
130	Mechanical Limit during PlaneMatch	Press E button (s) on the remote control or the OK button in the app to delete the error message. Check if the receiver was set out of the slope range (+/- 9%, 5°).

140	Laser beam blocked	Press E button (s) on the remote control or the OK button in the app to delete the error message. Make sure there are no obstacles between the laser and HL760/CR700 receiver during the operation. The receiver needs to receive the laser beam all the time during this function.
141	Time out – Alignment could not be completed in the allowed time.	Press E button (s) on the remote control or the OK button in the app to delete the error message. Check radio operating range / connection. Check if the laser setup is stable.
150	No receiver – HL760 Receiver not available for single axis automatic function	Press E button (s) on the remote control or the OK button in the app to delete the error message. Make sure the HL760/CR700 has been switched on and is paired with the laser. The HL760/CR700 may have turned off automatically. Check if the receiver is within radio range.
152	No receiver - The laser searched for the receiver but could not find it	Press E button (s) on remote control or the OK button in the app to delete the error message. Check the operating range for auto function and restart the function. The receiver has been placed too far away, too high, or too low. Check if the receiver has been placed along the wrong axis. If so place the receiver along the correct axis.
153	Lost receiver - The laser searched and found the receiver but then lost it.	Press E button (s) on the remote control or the OK button in the app to delete the error message. Check the operating range for auto function and restart the function. The receiver has been placed too far away, too high, or too low. Check if the receiver has been placed along the wrong axis. If so place the receiver along the correct axis.
155	More than one paired receiver is available during automatic alignment function.	Press E button (s) on the remote control or the OK button in the app to delete the error message. Make sure only one receiver is turned on.
157	After an established and started receiver operation this error indicates a lost communication.	Press E button (s) on the remote control or the OK button in the app to delete the error message. Check the operating range for auto function and restart the function. The receiver has been placed too far away.
160	X or Y level sensor defect	Contact your service dealer.

22 Check Accuracy

22.1 Checking accuracy of the Y- and X Axis

1. Set up the laser 30 m (100 ft.) from a wall and allow it to level.
2. Raise/lower the receiver until you get an on-grade reading for the $-Y$ axis. Using the on-grade marking notch of the receiver as a reference, make a mark on the wall.

Note: For increased precision, use the ultra-fine sensitivity setting (0.5 mm / 1/32in.) on the receiver.

3. Rotate the laser 180° (+Y axis towards the wall) and allow the laser to re-level.
4. Raise/lower the receiver until you get an on-grade reading for the +Y axis. Using the on-grade marking notch as a reference, make a mark on the wall.
5. Measure the difference between the two marks. If they differ more than 3 mm at 30 m (1/8 inch at 100 feet), the laser needs calibrating.
6. After checking the Y axis, rotate the laser 90°. Repeat the above starting with the +X axis facing the wall.

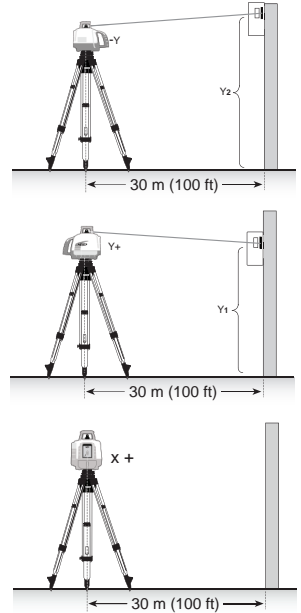

23 Service

23.1 Technician Menu

Access to Technician menu, see pic 47, is only possible for trained service dealer personnel.

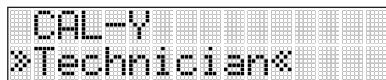

Pic 47 Technician menu

24 Protect the Unit

Do not expose the unit to extreme temperatures or temperature changes (do not leave inside the car). The unit is very robust and can resist damage if dropped even from tripod height. Before continuing your work, always check the leveling accuracy. See section 22 Check Accuracy.

The laser can be used indoors and outdoors.

25 Cleaning and Maintenance

Dirt and water on the glass parts of the laser will influence beam quality and operating range considerably. Clean with cotton swabs.

Remove dirt from the housing with a lint-free, warm, wet and smooth cloth. Do not use harsh cleaners or solvents.

Allow the unit to air dry after cleaning it. Never put the unit wet into the carrying case for storage.

26 Protecting the Environment

The unit, accessories, and packaging ought to be recycled.

All plastic parts are marked for recycling according to material type.

Note: Do not throw used batteries into the garbage, water, or fire. Remove them in compliance with local environmental requirements.

27 Warranty

Spectra Precision LLC warrants the LL1505C to be free of defects in material and workmanship for a period of five years. Spectra Precision LLC or its authorized service center will repair or replace, at its option, any defective part, or the entire product, for which notice has been given during the warranty period. If required, travel and per diem expenses to and from the place where repairs are made will be charged to the customer at the prevailing rates. Customers should send the product to the nearest authorized service center for warranty repairs or exchange, freight prepaid. Any evidence of negligent, abnormal use, accident, or any attempt to repair the product by other than factory-authorized personnel using Spectra Precision LLC certified or recommended parts, automatically voids the warranty. Special precautions have been taken to ensure the calibration of the laser; however, calibration is not covered by this warranty. Maintenance of the calibration is the responsibility of the user.

The foregoing states the entire liability of Spectra Precision LLC regarding the purchase and use of its equipment. Spectra Precision LLC will not be held responsible for any consequential loss or damage of any kind. This warranty is in lieu of all other warranties, except as set forth above, including any implied warranty merchantability of fitness for a particular purpose, are hereby disclaimed. This warranty is in lieu of all other warranties, expressed or implied.

28 Technical Specification

28.1 Technical Specifications LL1505C Laser

Leveling Accuracy ^{1,2} , Horizontal	± 1.5mm / 30m (1/16 in @ 100 ft) 10 arc seconds
Rotation Speed ¹	300, 600, 900 rpm
Operational Diameter ^{1,3} with HL760	Typ. 1200 m (4000 ft)
PlaneMatch Distance	Typ. 80 m (260 ft)
Laser Type	630 – 643 nm
Laser Class	Class 2
Self-Leveling Range	Typ. ± 5° (± 8.7%)
Radio Range (HL760) ^{1,3,4}	Up to 100m (330 ft)
Operating Temperature (inside product temperature)	-20°C to +50°C (-4°F to +122°F)
Storage Temperature	-25°C to +70°C (-13°F to +158°F)
Power Source	10000mAh NiMH battery back or 4 x 1.5V D alkaline batteries
Battery Lifetime (NiMH)	typ. 55 hours
Battery Charging Time	< 10 hours
Battery Charging Temperature	5°C to +40°C (+41°F to +104°F)
Charger Input Voltage	100V-240VAC ± 10%, 50 Hz – 60 Hz
Tripod Attachments	5/8 x 11 horizontally and vertically
Dust and Water Proof (IP)	IP66
Max. Humidity	90%
Over Voltage Category	I
Pollution Degree	2
Weight	3.49 kg (7.7 lbs) (incl. Battery pack)
Product Dimensions	240mm x 280mm x 180mm (9.45 in x 11.02 in x 7.09 in)

1 at 21°C / 70°F

2 along the axis

3 under optimal atmospheric circumstances

4 when product is set up at a height of min. 1m / 3ft

28.2 Technical Specifications RC1402 Remote Control

Radio operating range ^{1,3,4}	Up to 100m (330ft)
Power Source	2 x 1.5V AA alkaline batteries
Battery life ¹	Typ. 130 hours
Dust and Waterproof	IP66
Weigh (without batteries)	0,124kg (0.27lbs)

¹ at 21°C / 70°F

² along the axis

³ under optimal atmospheric circumstances

⁴ when product is set up at a height of min. 1m / 3ft

29 Declaration of Conformity

We

Spectra Precision (Kaiserslautern) GmbH

declare under our sole responsibility that the products

LL1505C and optional RC1402

to which this declaration relates is in conformity with the following standards:

EN 55014-1:2017, EN 55014-2:2015, EN 60825-1:2014 + Amdt., EN 61010-1:2010 + Amdt., EN IEC 62311:2020, ETSI EN 300328 V2.2.2:2019, ETSI EN 301489-1 V2.2.3:2019, ETSI EN 301489-17 V3.2.4:2020

Applied European directives: **2011/65/EU RoHS Directive, 2014/53/EU Radio Equipment Directive**

30 UKCA

We declare under our sole responsibility that the products LL1505C and RC1402 are in conformity with the following relevant UK Statutory Instruments:

2012 No. 3032 The Restriction of the Use of Certain Hazardous Substances in Electrical and Electronic Equipment (RoHS)

2017 No. 1206 The Radio Equipment Regulations

Relevant designated standards:

EN 55014-1:2017, EN 55014-2:2015, EN 60825-1:2014 + Amdt., EN 61010-1:2010 + Amdt., EN IEC 62311:2020, ETSI EN 300328 V2.2.2:2019, ETSI EN 301489-1 V2.2.3:2019, ETSI EN 301489-17 V3.2.4:2020 EN IEC 61000-6-2:2019

31 Electro-Magnetic Compatibility

Compliance statement (part 15.19): This device complies with part 15 of the FCC Rules. Operations is subject to the following tow conditions: (1) this device may not cause harmful interference, and (2) this device must accept any interference received, including interference that may cause undesired operation.

Warning (part 15.21): Changes or modifications not expressly approved by the party responsible for compliance could void the user's authority to operate the equipment. This in particular is applicable for the antenna, which has been delivered with the LL1505C and RC1402. Under Industry Canada regulations, this radio transmitter may only operate using an antenna of a type and maximum (or lesser) gain approved for the transmitter by Industry Canada. To reduce potential radio interference to other users, the antenna type and its gain should be so chosen that the equivalent isotropically radiated power (e.i.r.p.) is not more than that necessary for successful communication.



Spectra Precision (USA) LLC
3265 Logistics Lane, Suite 200
Dayton, OH 45377
U.S.A.
Phone +1 888-527-3771

Spectra Precision (Kaiserslautern) GmbH
Am Sportplatz 5
67661 Kaiserslautern
GERMANY
Phone +49-6301-711414

[spectraprecision.com](https://www.spectraprecision.com)

